



### Asian Granito India Ltd.

Regd. & Corp. Office  
202, Dev Arc, Opp. Iskcon Temple, S.G. Highway,  
Ahmedabad - 380 015, Gujarat, INDIA.

Phone: +91 79 66125500/698 | Fax: +91 79 66125600/66058672  
CIN: L17110GJ1995PLC027025

E-mail: info@aglasiangranito.com | Web: www.aglasiangranito.com

Follow Us: 1800 123 3455  
Toll-free: Mon-Sat 10am-6pm



Scan code to  
Download  
AGL Tiles App



Scan code to  
Download  
AGL Tiles  
Catalogue



Scan to Find  
Exclusive  
Store



Scan code for  
360° Tour

MAY 2024



Premium  
*ka* Pappa



Beauty of SLEEK &  
MODERN *Surfaces*

GRESTEK  
**MARBLEX** V9

GLAZED VITRIFIED SLABS

800x3000mm | 800x2400mm | 1200x1800mm | 800x1600mm

AGL Premium ka Pappa

V9

GLAZED VITRIFIED SLABS

# ABOUT US

At AGL, we have been leading the change by continuous innovation, setting higher goals, achieving the unthinkable and creating new benchmarks. This has enabled us to clock net consolidated turnover of ₹1562 Crores (US \$190 Million) in FY22-23, making us giant in the space décor industry. In the short span of 23 years, we are one of India's largest groups, with a global footprint across 100 countries. Today,

AGL has enhance its product range from Tile to Marble, Quartz and now in Bathware as well.

The research and development center at every AGL plant is well equipped with all the latest testing methods and the products are thoroughly tested for quality before delivery. It is ensured that every product matches the highest international quality standards.



## ADVANCE TECHNOLOGIES & KEY PROCESS



**14** ULTRA-MODERN MANUFACTURING UNITS IN INDIA\*

\* Including JVs and CMUs  
\*\* Includes contract labour



From ceramic tiles to latest Glazed Vitrified Tiles & Double Charge Vitrified Tiles; Roto Drum to New Digital Technology, AGL dominates the most diverse array of designs across the entire Tile, Marble & Quartz product range. Modernization plays a pivotal role for the company, which becomes evident from our 09 ultra modern plants across Gujarat. Spread over an area of 3,20,000 sqm these plants unflinching produce unbeatable class products every day. Therefore, we are proud to acquire the certifications from ISO and Green Building.

Asian Granito India Limited has debunked the myth that leadership in design is a forte only of foreign players by achieving the position through an ideal mix of creativity and technology. It has been the champion in introducing innovative digital printing technology with a technical collaboration with SACMI, Italy. A world-class Quality Management System has enabled us to build a portfolio that is truly avant-garde.

A : Latest Press with ultra modern feeder  
B : Digital Printing Technology -14 Unit  
C : World's Widest Kiln First in India  
D : Auto check of planarity & rectangularity of tiles  
E : Continua + latest press system from Sacmi, Italy

<b>54.5</b> Million sqm Production Capacity per Annum*	Consolidated Net turnover <b>₹1562</b> .cr. (US \$190 million)	<b>1400+</b> Designs	<b>30+</b> Different sizes	<b>12</b> Display centres
<b>6000+</b> Employees Includes contract labour	<b>14</b> Manufacturing Units**	Exports in <b>100+</b> Countries	Trade network in <b>35</b> States & UTs of India	<b>235+</b> Showrooms
<b>11+</b> Digital Printing Technology	First to bring world's largest <b>5</b> line Kiln setup in India.	<b>1.4</b> Million+ Facebook followers	<b>1400+</b> Touch point	

GLOBAL  
PRESENCE IN  
OVER 100+  
COUNTRIES

YOUNGEST &  
FASTEST GROWING  
TILE COMPANY  
IN INDIA

LARGEST  
SINGLE  
LOCATION  
PLANT IN INDIA

ONE OF TOP 4  
LISTED CERAMIC  
TILES COMPANIES  
IN INDIA

# AWARDS AND RECOGNITION

Achievements of trusted and innovative brand in the ceramic industry

Today, AGL has been performed the best to give excellent product and services across the globe and in result, AGL has been recognized by top media houses like Readers' Digest, The Economic Times and Fortune India. AGL is certified with ISO 9001:2015 and ISO 14001:2015 for its quality management and environmental management system and also products are certified with CE standards.



AGL is now MEGA BRAND Recognition by ARCHITECTURE + DESIGN - 2016



ET INDUSTRY LEADERS 2021



Recognised as one of the Best Brand by The Economic Times -2022



Recognised as one of the Best Brand by The Economic Times -2023

# CERTIFICATIONS



ISO 9001 : 2015



ISO 9001 : 2015

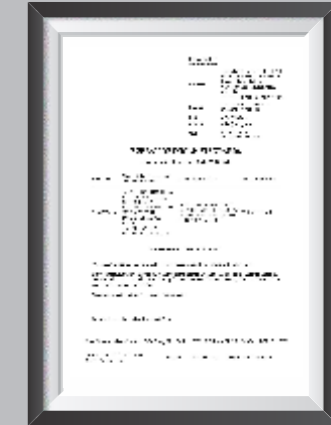

BIS CERTIFIED



CE CERTIFIED



CERTIFIED TWO STAR EXPORT HOUSE



GRIHA CERTIFIED



IIID CERTIFIED

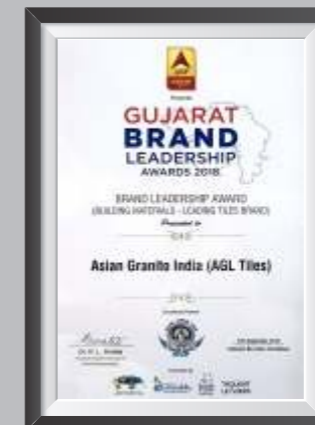

AWARDED FOR BRAND LEADERSHIP



IGBC CERTIFIED

## PRESTIGIOUS PROJECTS

## MANY NATIONAL & INTERNATIONAL PROJECTS

Today AGL is the preferred brand for several National & International Projects. We are partnering several private residential projects, commercial projects, showrooms, port authorities, religious centers, and international projects. Here are selected few of them:



Project : Cleveland Cycle Werks Showroom

### Government Projects



### Banks



### Corporates



### Builders



### Hospital



### Automobiles



### Telecom



### Multiplexes



### Hotels



### Apparel



### Eatery Brands



### Real Estate



and many more ...



## OUR EXPERIENCE CENTRES

"Team AGL is making efforts to simplify product selections very nearer to you. Keeping in mind better service and easy access to AGL products, your company has opened world class display centres across various metro cities of India. These showrooms are avant-garde with contemporary product applications of Tiles, Marble, Quartz and its latest Bathware range of products. We are sure that your visit to AGL showroom definitely helps you in right product selection and leave long lasting impressions in your mind. Below are few glimpse over the showroom.



AHMEDABAD | MORBI | HIMATNAGAR | MUMBAI | BANGALURU  
 COCHIN | HYDERABAD | JAIPUR | DELHI | KOLKATA

## TOUGH AND RESILIENT WITH TIMELESS AESTHETIC ELEGANCE



### GRESTEK **MARBLEX**

#### TRANSFORM SPACES WITH GRAND FORMATS OF LUXURY



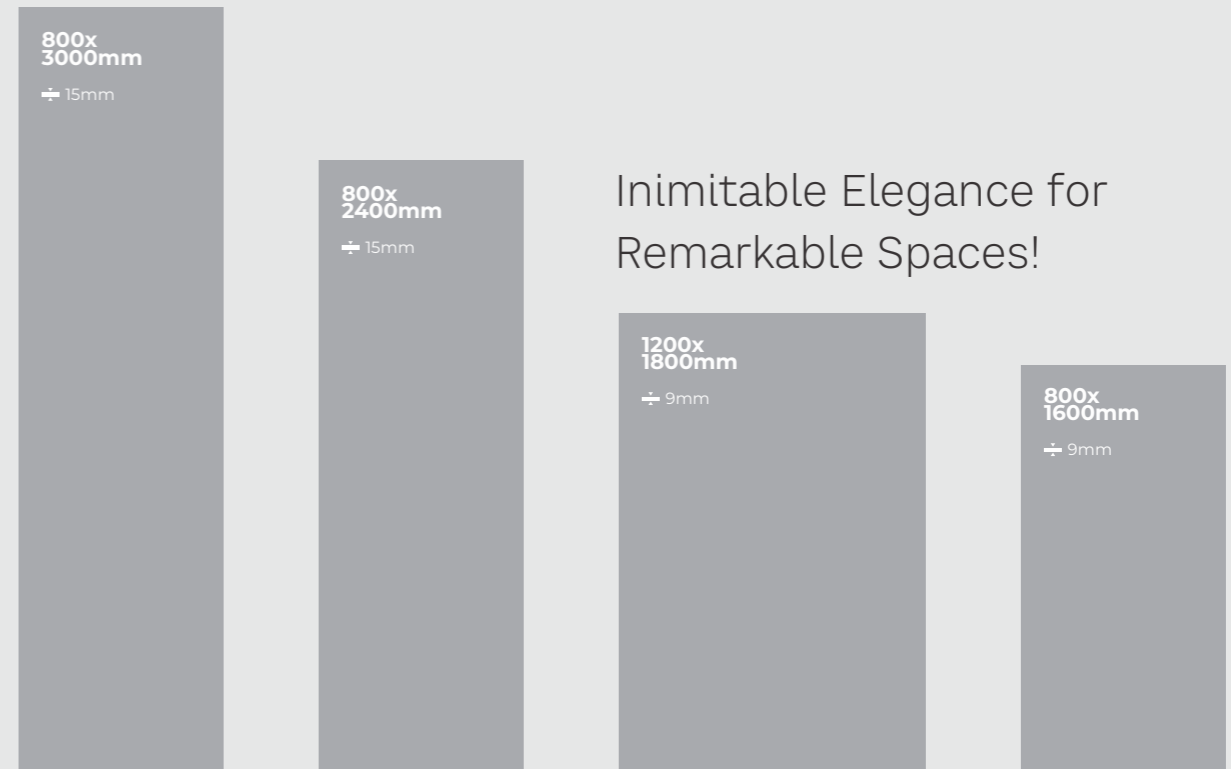









AGL's MarbleX collection is truly exceptional, Boasting extraordinary magnificence and unparalleled features. With grand sizes ranging 800x3000mm, 800x2400mm, 1200x1800mm, and 800x1600mm. This collection is truly remarkable and incomparable.



#### UNMATCHED STRENGTH & ELEGANCE

These surfaces provide an extra edge with feature-rich attributes like resistance to weather and chemicals, easy-to-clean and maintain, abrasion proof, stain and scratch resistant that do not require special care. Create your envisioned ambiance for a hassle-free lifestyle.

#### TILE FEATURES

- |  |   |  |  |
|--|---|--|--|
|  HIGH DURABILITY  |  HYGIENIC SURFACES |  LOW WATER ABSORPTION |  NANO POLISHED    |
|  FLOOR TILES      |  FIRE RESISTANCE   |  EASY TO CLEAN        |  FROST RESISTANCE |
|  STAIN RESISTANCE |  EASY TO INSTALL   |  SCRATCH RESISTANCE   |  ECO FRIENDLY     |



IRIDIUM



IRIDIUM SANA SUPREME



IRIDIUM GARNET SKY



IRIDIUM HOLLAND ICE



IRIDIUM



IRIDIUM THORN WHITE



KITCHEN ISLAND, WALL & FLOOR - IRIDIUM THORN WHITE



BATHROOM WALL & FLOOR - IRIDIUM SANA SUPREME



IRIDIUM KAMPALY IVORY



IRIDIUM FRIESLAND SILK



IRIDIUM BELGIUM ROSSATA



IRIDIUM DUBBO BEIGE



IRIDIUM ARUBA ARMANI



IRIDIUM GEXO STEEL







VELVET



VELVET DACIO BIANCO



VELVET AUSTIS BRONZE

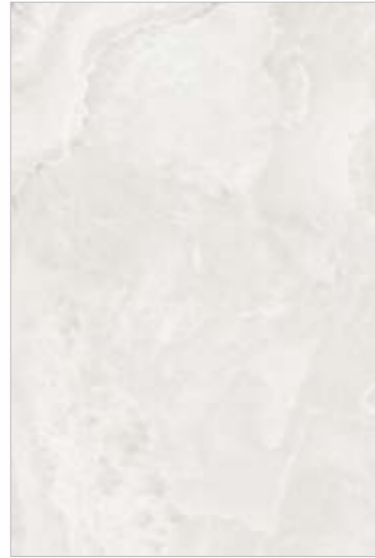

VELVET GRESSO ONYX PEARL



VELVET RIMINI TAUPE



VELVET AZZATE BEIGE



VELVET ORTE BEIGE



WALL & FLOOR  
VELVET RIMINI TAUPE



VELVET SPIDER CREMA

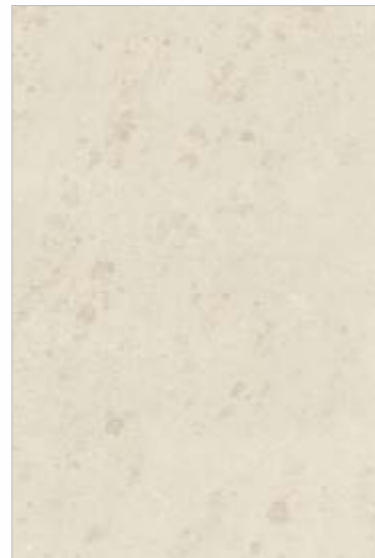

VELVET SLOTEN CREMA



VELVET



VELVET ELICE BIANCO



VELVET FARAYA BONE

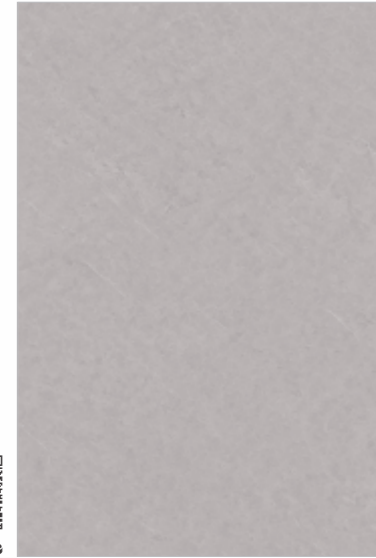

VELVET EMILY GRIS



RESTAURANT FLOOR - VELVET EMILY GRIS



POLISH



STATUARIO NUOVA



ROYAL SATVARIO



CUMANA SATVARIO FP



DACIO BIANCO FP



MICHAEL ANGELO ROCIO



CALCUTTA ORO



POLISH



DIA SUNSHINE BIANCO FP



ELIGHT WHITE FP



CIARA GOLD FP

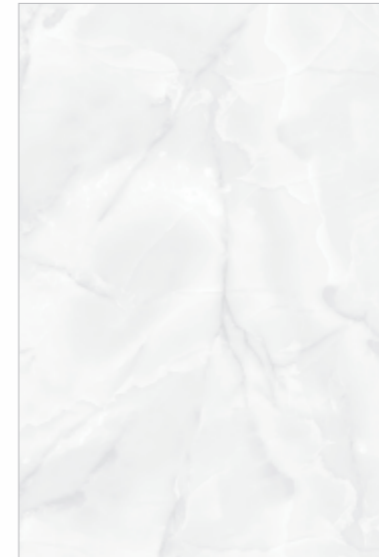

HAZEL ONYX



FLUID ONYX

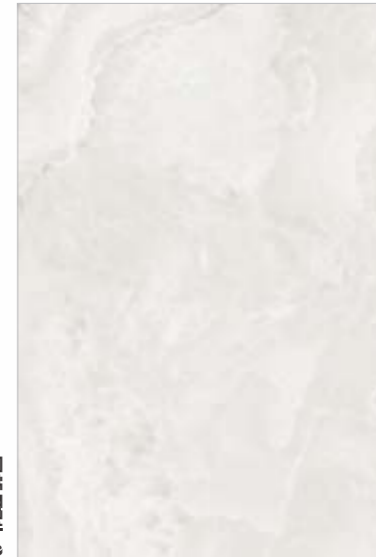

GESSO ONYX PEARL FP



FLOOR - CUMANA SATVARIO FP

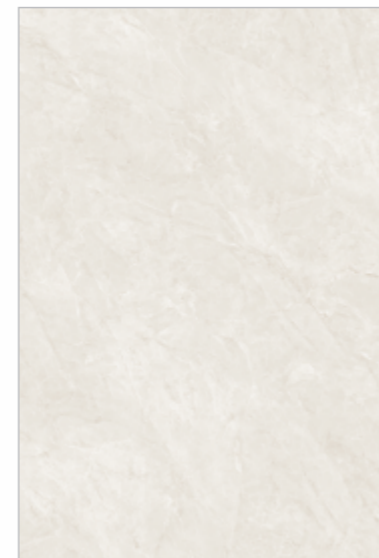

EVITA MARFIL

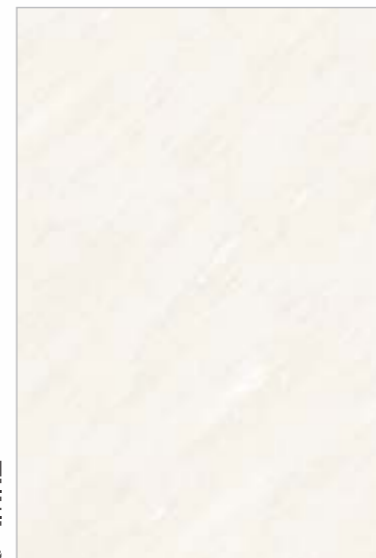

CITEINE CREMA FP



NORA ONYX

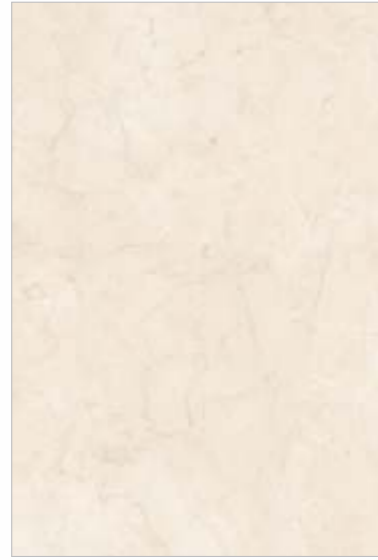

ISABEL BIANCO

POLISH



DEVON BEIGE FP



DELICATA BOTTOCINO CREMA FP



MARFIL CREMA



CITADEL BEIGE



EMMA CREMA FP



ETNA BOTTOCINO CREMA FP

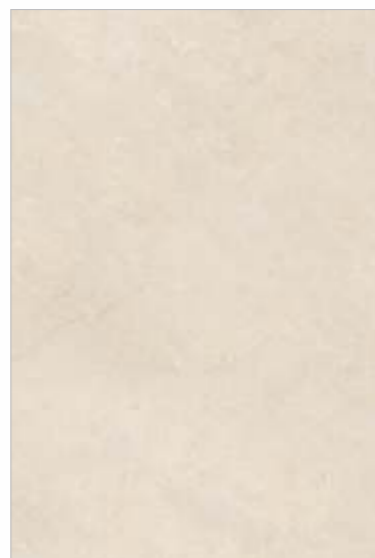

ENIGMA CREMA FP



MEGAN CREMA



SCAN FOR VIRTUAL



SCAN FOR VIRTUAL



SCAN FOR VIRTUAL



SCAN FOR VIRTUAL



SCAN FOR VIRTUAL



SCAN FOR VIRTUAL



SCAN FOR VIRTUAL



SCAN FOR VIRTUAL



SCAN FOR VIRTUAL



ESCAMAS BEIGE

POLISH



CHICAGO CREMA FP



ETON GREAK FP

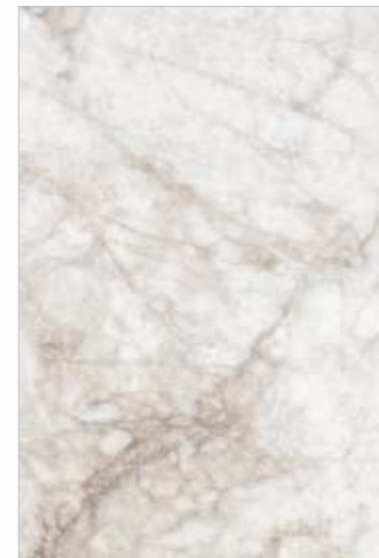

FIDENZA ICE FP

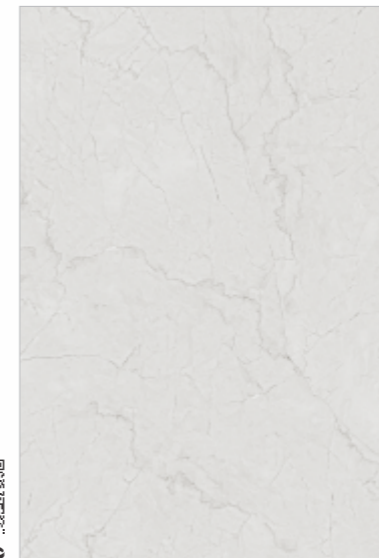

DELICATA BOTTOCINO GREY FP



RADICE GRIS



SCAN FOR VIRTUAL



SCAN FOR VIRTUAL



SCAN FOR VIRTUAL



SCAN FOR VIRTUAL



SCAN FOR VIRTUAL



SCAN FOR VIRTUAL



FLOOR - FIDENZA ICE FP



FARAYA GREY FP



AMEXA GRIS



ALITIA GREY FP



EMILY GREY FP



DUERO GRIS FP

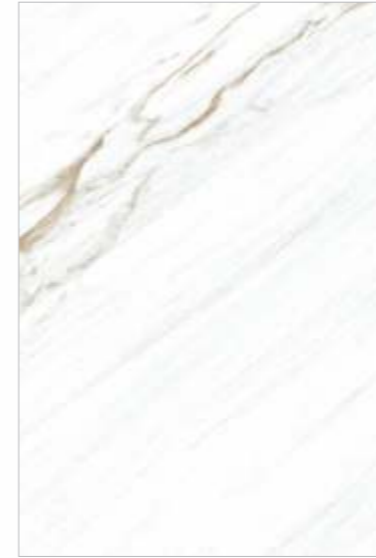

MICHAEL ANGELO GRIGIO



ONYX NYLE



BLAIR GRIS

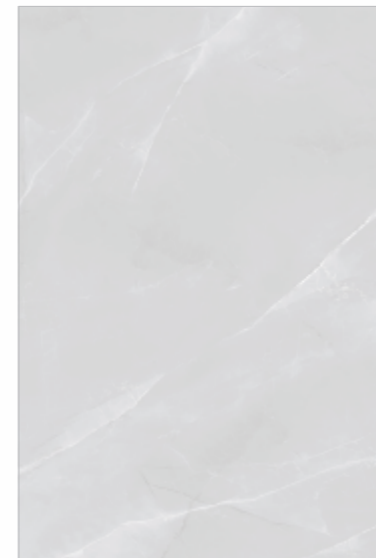

CLORA GRIS



MANTECA ESHANA OLIVE



MANTECA ICONA NOIR

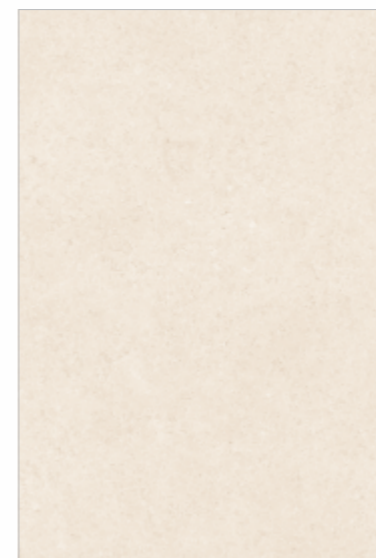

EVA CREMA



CLORA CREMA



KYLA BEIGE



IRIDIUM

IRIDIUM AROMA BEIGE



IRIDIUM ARIANA IVORY



IRIDIUM TORRETO GREY



IRIDIUM VENICE ORO



IRIDIUM ALVIRA BIANCO



IRIDIUM VIGASIO BLUE



IRIDIUM ALLURE GREY



IRIDIUM LAURINO GRIS



FLOOR - SILK FLORITO



SILK FLORITO

SATIN



CARVING

CONVERSE WHITE



OPULENCE ALVA IVORY



WALL & FLOOR - OPULENCE VIGASIO AQUA



LITE BOTTOCHINO CREMA



OPULENCE AINA BEIGE



TRAVERTINE BEIGE



OPULENCE VIGASIO AQUA



SOFITA BEIGE

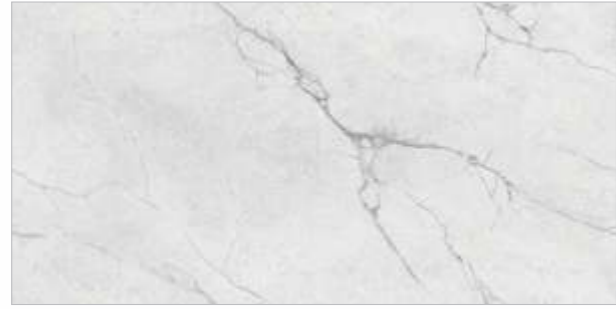

CARVING



SCAN FOR VIRTUAL



SCAN FOR VIRTUAL

VENUS GRIS

URBEN STEEL



CARVING

MULTI COLOUR



SCAN FOR VIRTUAL



SCAN FOR VIRTUAL

OPULENCE CASINA STATUARIO

OPULENCE CASINA STATUARIO LINER



SCAN FOR VIRTUAL



SCAN FOR VIRTUAL

OPULENCE BRENTA CREMA

OPULENCE BRENTA CREMA LINER



SCAN FOR VIRTUAL



SCAN FOR VIRTUAL

OPULENCE BRENTA SILVER

OPULENCE BRENTA SILVER LINER



SCAN FOR VIRTUAL



SCAN FOR VIRTUAL

OPULENCE BRENTA GREY

OPULENCE BRENTA GREY LINER



HIGH GLOSS



SCAN FOR VIRTUAL



SCAN FOR VIRTUAL

GLITZ ROMENO BLISS

GLITZ MERANO AQUA





INFINITY POLISH



AYLA CREMA FP



EMPERIO CREMA



RIVER BEIGE



ARMENIA CREMA



BOTTOLIN BEIGE



AYLA LIGHT GRIS FP

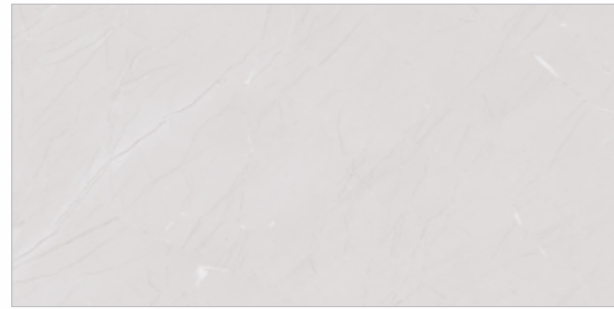

LAPIDA BIANCO



BOTTOLIN GREY



BETTY GRIS FP



POLISH



ALPI SUPREMO FP



CLASSIC CALACATTA



PRO STATUARIO BIANCO

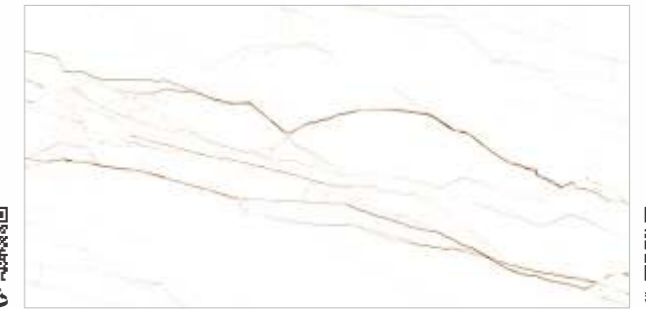

EXOTIC CREMA FP



CARRARA SIA



ATLAS PEARL FP



WALL & FLOOR - ALPI SUPREMO FP



POLISH



AURIC GLORY FP



BIANCO FANTASTICO FP



AZUMA CLOUD FP



BLOX KNIGHT FP



SENSO WHITE



BLAZE BIANCO FP



WALL & FLOOR - BLOX KNIGHT FP



POLISH



ROYAL ONYX



SUPREME ONYX



BAYA CREMA FP



BILANCIA BRONZE FP



WALL & FLOOR - BILANCIA BRONZE FP





POLISH



SCAN FOR VIRTUAL

ARMANI CREMA FP



SCAN FOR VIRTUAL

NORDIC BEIGE

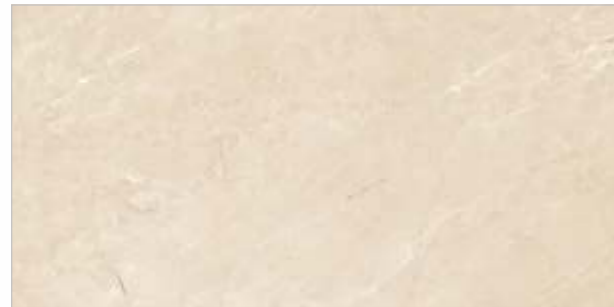

SCAN FOR VIRTUAL

ORNICA CREMA FP



SCAN FOR VIRTUAL

BLAZE MARFIL FP



SCAN FOR VIRTUAL

BOHARS BEIGE FP



SCAN FOR VIRTUAL

ARTY IVORY FP



POLISH



SCAN FOR VIRTUAL

EVITA MARFIL



SCAN FOR VIRTUAL

FLORITO



SCAN FOR VIRTUAL

AVANI BIANCO FP



SCAN FOR VIRTUAL

AVA TAUPE FP



SCAN FOR VIRTUAL

AVANI BEIGE FP



SCAN FOR VIRTUAL

DAINO BEIGE



SCAN FOR VIRTUAL

BRECCIA AURORA FP





POLISH



ALTINO CEMENTO FP



RIVIERA NATURAL



BELFAST GRIS FP



INDUS GRIS



NORDIC GREY



ARMANI GREY FP



WALL - NORDIC GREY



BARCELONA GREY FP



AVA GREY FP



FULLBODY-POLISH



RIMINI BIANCO



RIMINI CREAMA



RIMINI DOVE GREY



FULLBODY-MATT



FB ANCONA SILVER



FB ANCONA BEIGE



FB ANCONA GIRGIO



FB ANCONA NERO



POOL AREA - FB ANCONA BEIGE

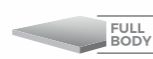

FULLBODY



GRANITI CREAMA (Polish) | ROCK GRANITI CREAMA (Matt)



FULLBODY



GRANITI BROWN (Polish) | ROCK GRANITI BROWN (Matt)

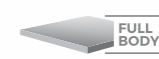

FULLBODY



GRANITI BIANCO (Polish) | ROCK GRANITI BIANCO (Matt)

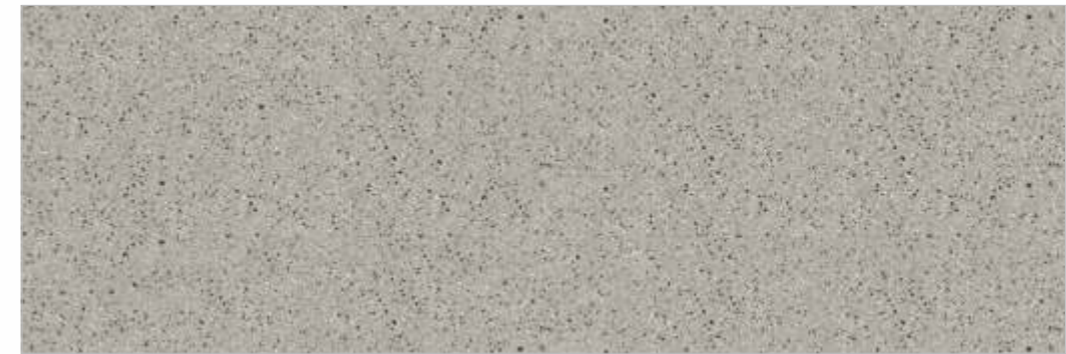

FULLBODY



GRANITI TAUPE (Polish) | ROCK GRANITI TAUPE (Matt)



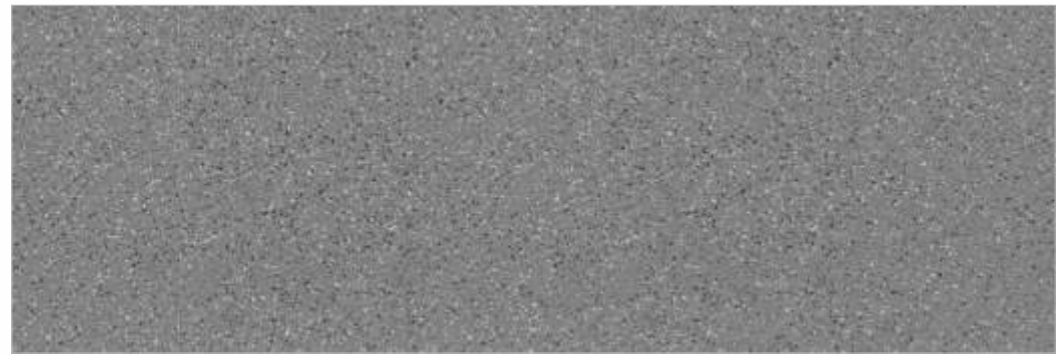

FULLBODY



GRANITI GRIS (Polish) | ROCK GRANITI GRIS (Matt)

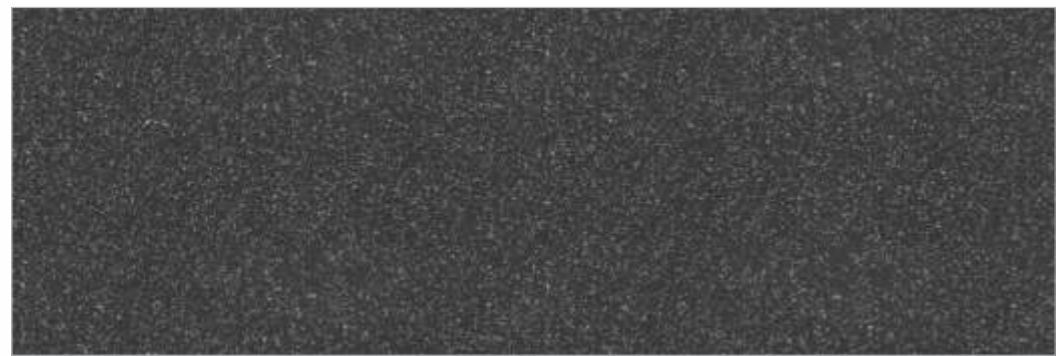

FULLBODY



GRANITI NERO (Polish) | ROCK GRANITI NERO (Matt)



FULLBODY



DOLCE BIANCO (Polish)



FULLBODY



DOLCE NERO (Polish)



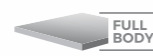

FULLBODY



GRIS (Polish) | GRIS MATT (Matt)

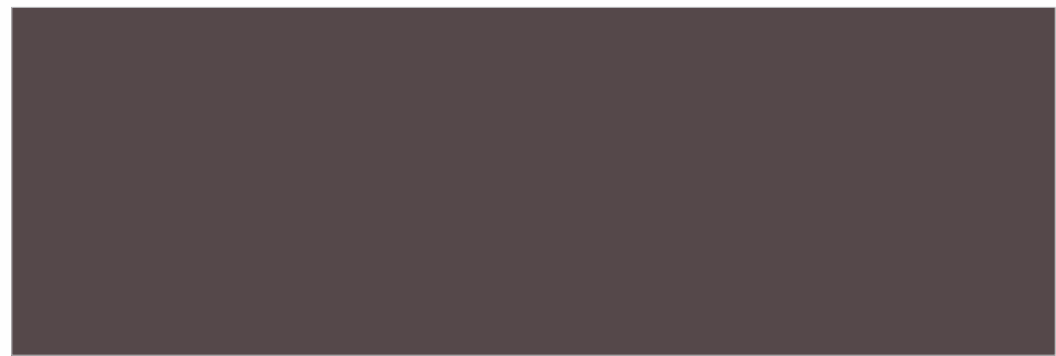

FULLBODY



BROWN (Polish) | BROWN MATT (Matt)



FULLBODY



DIAMOND NERO (Polish)

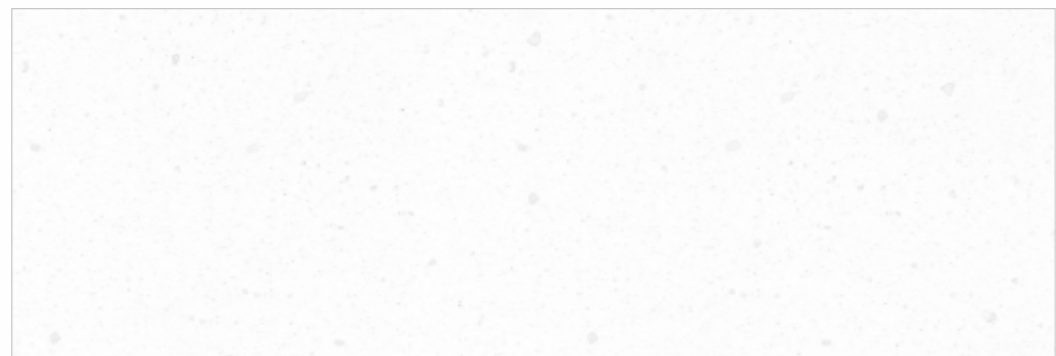

FULLBODY



LINOLEUM BIANCO (Polish)

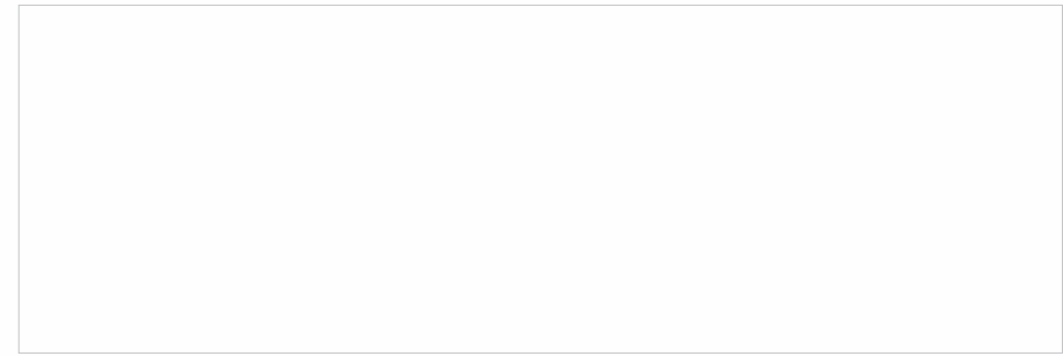

FULLBODY



DAIMOND BIANCO (Polish)

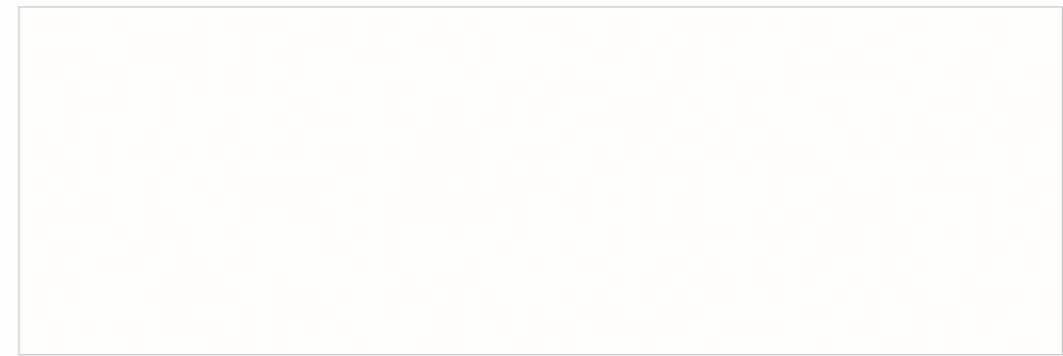

GLAZED BODY



SNOW WHITE (Polish)

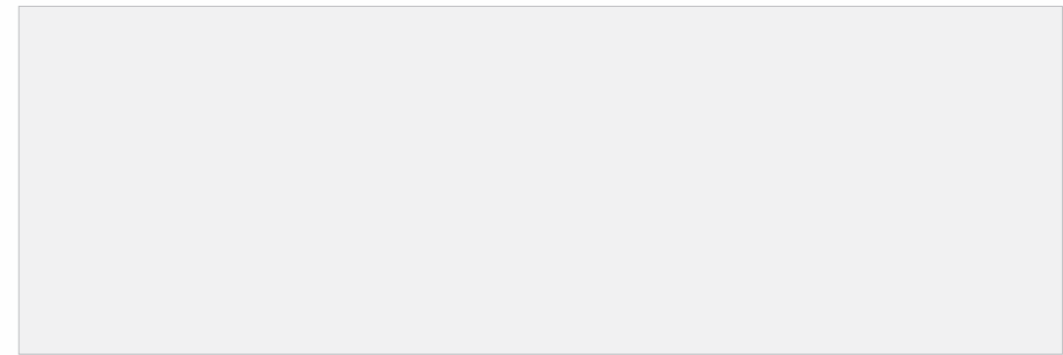

GLAZED BODY



PEARL BIANCO (Polish)



GLAZED BODY



NERO (Polish)



TIA BIANCO  
(Carving)

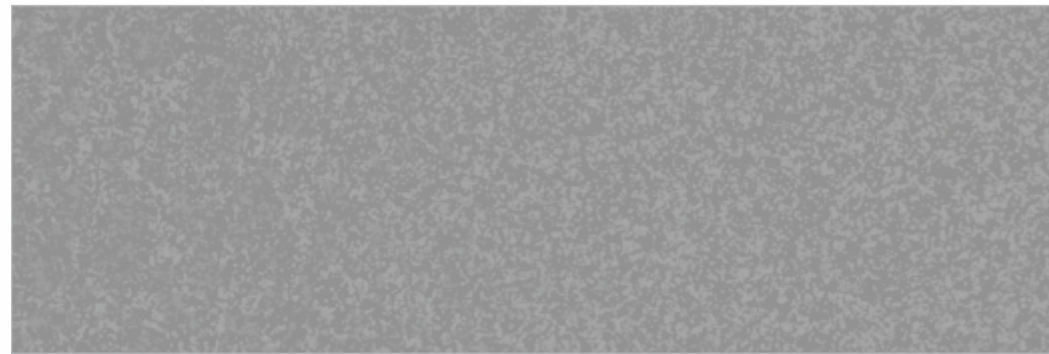

TIA GREY  
(Carving)



TIA NERO  
(Carving)



OFFICE TABLE - TIA NERO

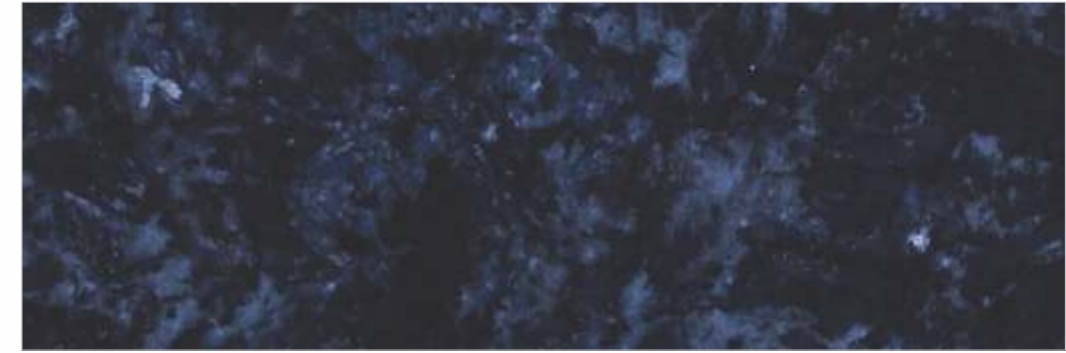

VOLGA BLUE  
(High Gloss)



MARMO VERDE  
(High Gloss)



WALL - MARMO VERDE

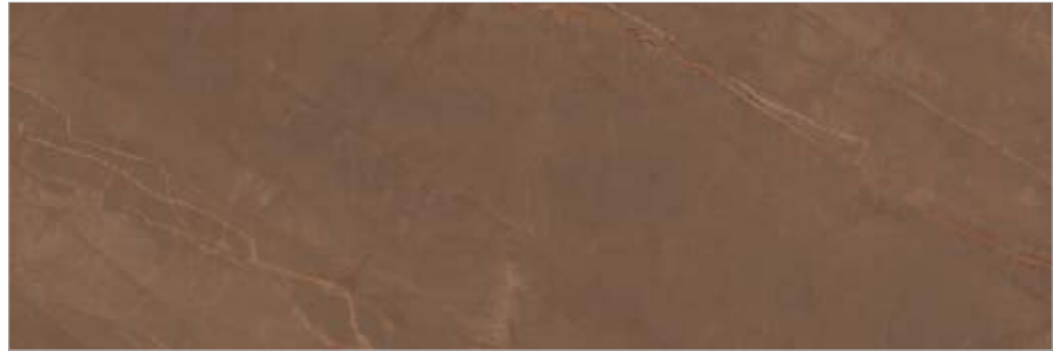

ARMANI BROWN  
(High Gloss)



SAN LORENZO  
(High Gloss)



WALL - SAN LORENZO



LASA BIANCO  
(Polish)



CALACATA NUEVO  
(Polish)



STATUARIO VIENNA  
(Polish)



CALACATA GOLD  
(Polish)



CREMA MARFIL  
(Polish)



SILVER RIO  
(Polish)



WALL & FLOOR - CREMA MARFIL



CALACATA FRESCO  
(Manteca)



SILVER FERRO  
(Manteca)



SHOWROOM FLOOR - SILVER FERRO



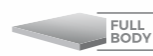

KLEAN MOON MIST  
(Polish)

KLEAN MOON MIST-MATT  
(Manteca)

NEW

FULLBODY



SCAN FOR VIRTUAL

SCAN FOR VIRTUAL



KLEAN BURLY  
(Polish)

KLEAN BURLY MATT  
(Manteca)

NEW

FULLBODY



SCAN FOR VIRTUAL

SCAN FOR VIRTUAL



KITCHEN TABLE - KLEAN MOON MIST, FLOOR - KLEAN BURLEY  
KITCH BACKSPLASH - KLEAN DORIAN GREY

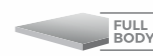

KLEAN GAIN STONE  
(Polish)

KLEAN GAIN STONE-MATT  
(Manteca)

NEW

FULLBODY



SCAN FOR VIRTUAL

SCAN FOR VIRTUAL

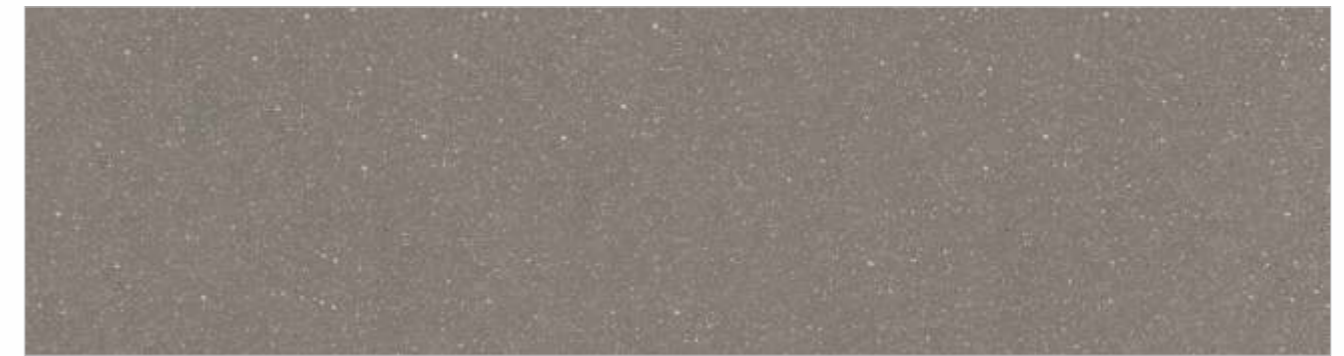

KLEAN DORIAN GREY  
(Polish)

KLEAN DORIAN GREY-MATT  
(Manteca)

NEW

FULLBODY



SCAN FOR VIRTUAL

SCAN FOR VIRTUAL

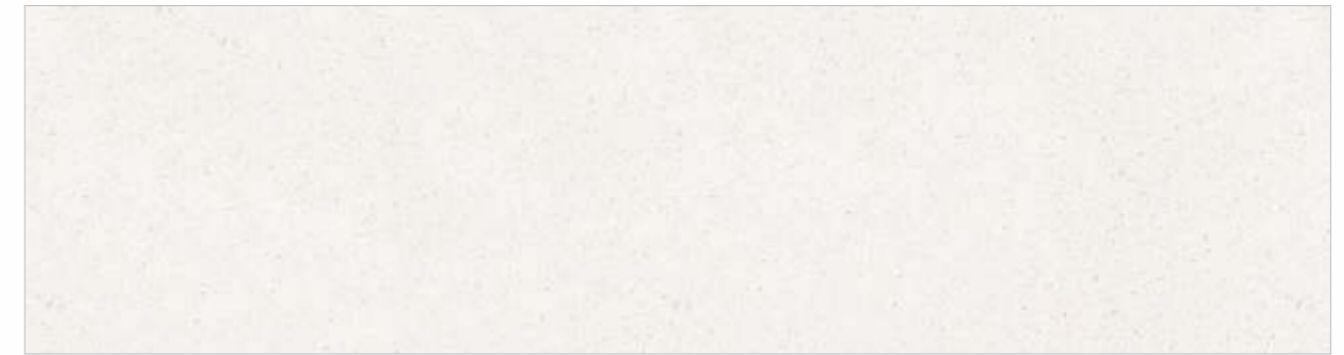

KLEAN WHITE  
(Polish)

KLEAN WHITE-MATT  
(Manteca)

NEW

FULLBODY



SCAN FOR VIRTUAL

SCAN FOR VIRTUAL



KLEAN BLACK  
(Polish)

KLEAN BLACK-MATT  
(Manteca)

NEW

FULLBODY



SCAN FOR VIRTUAL

SCAN FOR VIRTUAL

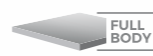

NEW

FULL BODY



GRANITI BIANCO (Polish) | ROCK GRANITI BIANCO (Matt)

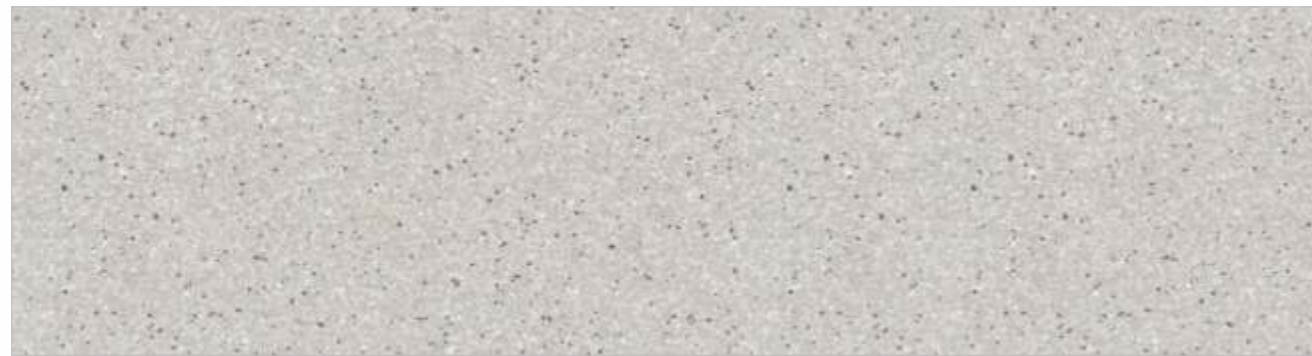

NEW

FULL BODY



GRANITI TAUPE (Polish) | ROCK GRANITI TAUPE (Matt)



TABLE TOP - GRANITI TAUPE

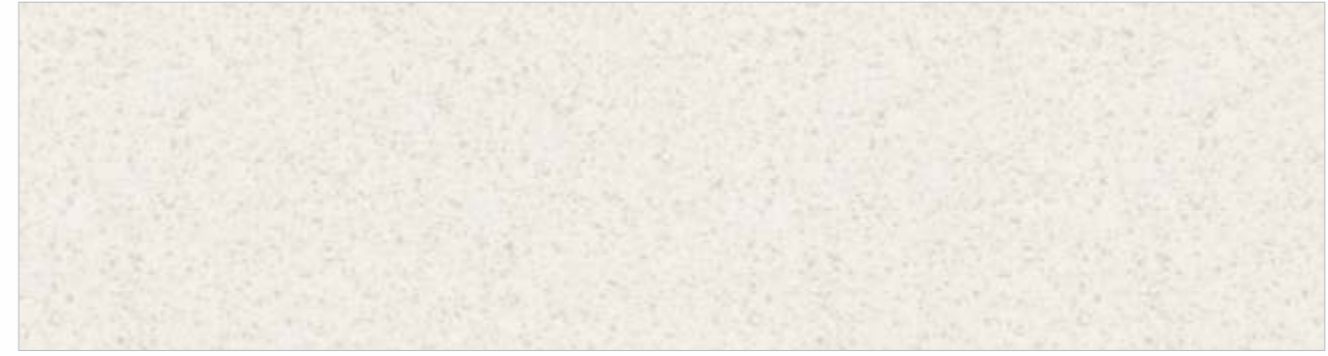
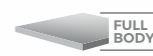

NEW

FULL BODY



GRANITI CREAMA (Polish) | ROCK GRANITI CREAMA (Matt)

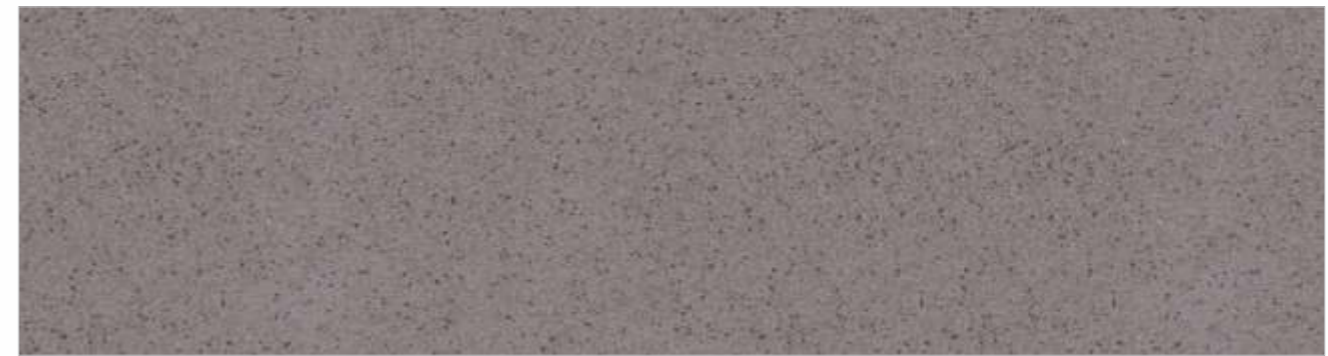

NEW

FULL BODY



GRANITI BROWN (Polish) | ROCK GRANITI BROWN (Matt)



TABLE TOP - GRANITI CREAMA

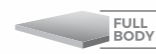

Glossy Matt Wall Floor Furniture

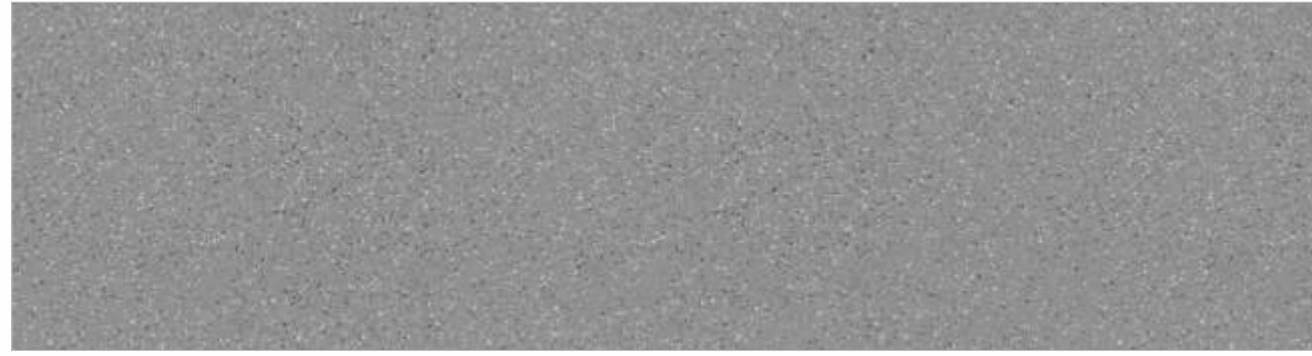

NEW

FULLBODY



GRANITI GRIS (Polish) | ROCK GRANITI GRIS (Matt)

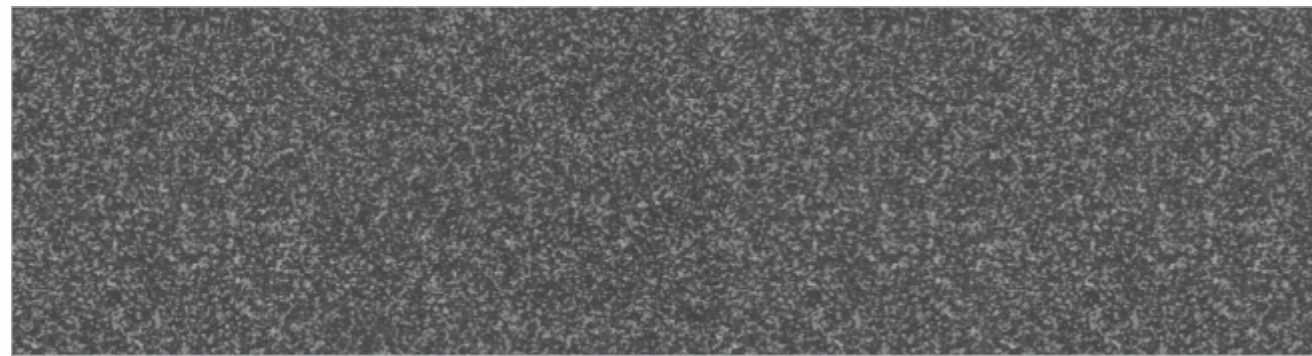

NEW

FULLBODY



GRANITI NERO (Polish) | ROCK GRANITI NERO (Matt)



TABLE - GRANITI NERO

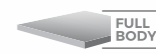

Glossy Wall Floor Furniture

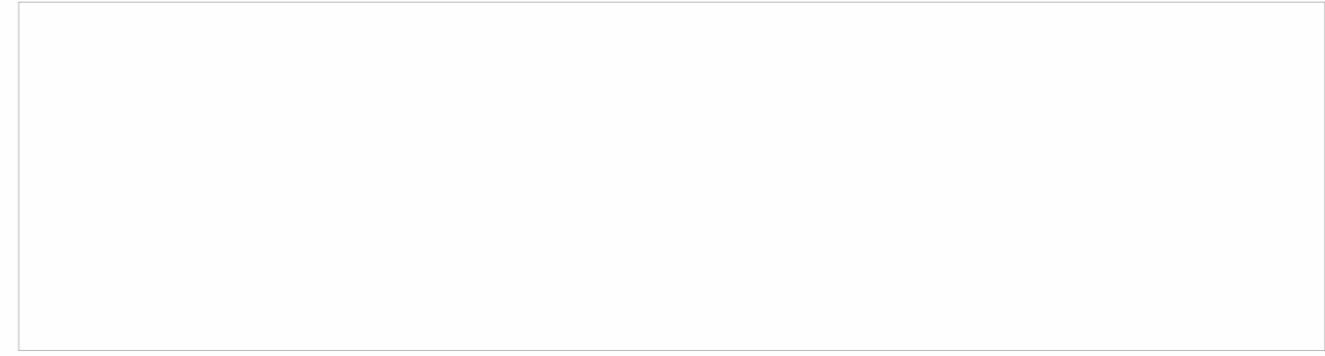

FULLBODY



GLACIER BIANCO (Polish)



FULLBODY



GOLDEN BROWN (Polish)



FULLBODY



GRIS (Polish)



FULLBODY



DIAMOND NERO (Polish)

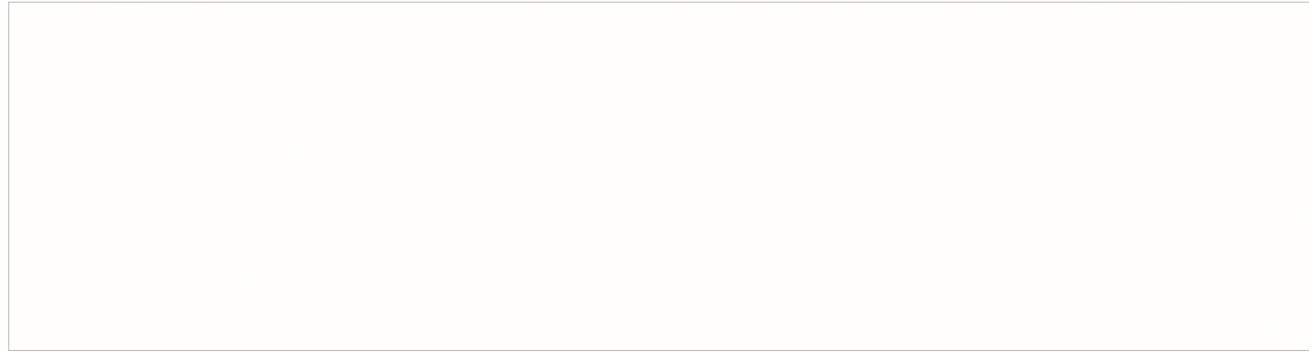

GLAZED BODY



SNOW WHITE  
(Polish)



GLAZED BODY



NERO  
(Polish)



TABLE TOP - SNOW WHITE



STATUARIO VENATO  
(Polish)



BRESCIA NATURAL  
(Polish)



JADE GREEN  
(Polish)



KITCHEN ISLAND - STATUARIO VENATO



CALACATA AURIC  
(Manteca)



SANTORINI BIANCO  
(Manteca)



LAUREN NERO  
(Manteca)



KITCHEN ISLAND -  
LAUREN NERO



BRESCIA BEIGE  
(Manteca)



BIANCO CHROMO  
(Manteca)



BASIN COUNTER - BIANCO CHROMO

## TECHNICAL SPECIFICATION FOR GVT

CHARACTERISTICS	Requirement as per ISO 13006:2018 Gr Bla E < 0.5%	Requirement as per IS 15622:2017 Gr Bla E < 0.08%	MEAN VALUE OF AGL	METHOD OF TESTING
<b>Regulatory Properties</b>				
Deviation In Length & Width	± 0.3%, ± 1.0mm	± 0.1%	<± 0.1%	ISO 10545 Part-2 IS 13630 Part-1
Deviation In Thickness	± 5.0%, ± 0.5mm	± 5.0%	± 4.0%	ISO 10545 Part-2 IS 13630 Part-1
Straightness of Edge	± 0.3%, ± 0.8mm	± 0.1%	<± 0.1%	ISO 10545 Part-2 IS 13630 Part-1
Rectangularity	± 0.3%, ± 1.5mm	± 0.1%	± 0.1%	ISO 10545 Part-2 IS 13630 Part-1
Surface Flatness	± 0.4%, ± 1.8mm	± 0.5%	± 0.2%	ISO 10545 Part-2 IS 13630 Part-1
Surface Quality	Min. 95% of Tiles shall be free from visible defects that would impair the appearance of a major area of the tiles	Min. 95% of Tiles shall be free from visible defects that would impair the appearance of a major area of the tiles	Min. 95% of Tiles shall be free from visible defects that would impair the appearance of a major area of the tiles	ISO 10545 Part-2 IS 13630 Part-1
Glossiness	-	-	90-95 in Glossy surface	Glossmeter

### Physical & Thermal Properties

Water Absorption % By Wt.	< 0.5, Ind. 0.6 Max.	< 0.08, Ind. 0.1 Max.	< 0.08%	ISO 10545 Part-3 IS 13630 Part-2
Flexural Strength (MOR) In N/mm <sup>2</sup>	Avr. 35, Ind. Min. 32	Avr. 35, Ind. Min. 32	Min. 40 N/mm <sup>2</sup>	ISO 10545 Part-4 IS 13630 Part-6
Breaking Strength in N	1300 N Min.	1300 N Min.	Min. 1300 N	ISO 10545 Part-4 IS 13630 Part-6
Bulk Density (gm/cc)	2.0 Min.	2.2 Min.	Min. 2.25	ISO 10545 Part-3 IS 13630 Part-2
Resistance to Surface Abrasion	Manufacturer to State Class	PEI II Min.	PEI III Min.	ISO 10545 Part-7 IS 13630 Part-11
Co-efficient of Linear Thermal Expansion from ambient temp to 100°C (K-1)	9x10 <sup>-6</sup> Max.	6x10 <sup>-6</sup> Max.	< 6x10 <sup>-6</sup>	ISO 10545 Part-8 IS 13630 Part-4
Thermal Shock Resistance	10 Cycles Min.	10 Cycles Min.	No Damage after 10 Cycles min.	ISO 10545 Part-9 IS 13630 Part-5
Moisture Expansion in mm/M	Test Method Available	0.02 Max.	Nil	ISO 10545 Part-10 IS 13630 Part-3
Crazing Resistance	Required	4 Cycles at 7.5 bar Min.	Resistance	ISO 10545 Part-11 IS 13630 Part-9
Frost Resistance	Resistance	Resistance	Resistance	ISO 10545 Part-12 IS 13630 Part-10
Moh'S Scratch Hardness	Min. 5	Min. 5	Min. 5	EN 101/IS 13630 Part-13

### Chemical Properties

Resistance To House hold Chemicals	No Damage	Min. Class AA	Class AA	ISO 10545 Part-13 IS 13630 Part-8
Resistance To Acids & Alkalis (Except HF Acid)	No Damage	Min. Class AA	Class AA	ISO 10545 Part-13 IS 13630 Part-8
Stain Resistance	Min. Class 3	Min. Class 1	Resistance	ISO 10545 Part-14 IS 13630 Part-8

## PACKING SPECIFICATION

Size (mm)	Thickness (mm)	Weight (Kg.)	No. of Tiles / Set	Area Sq. mtr./ Box
1200x1800mm	9 mm	92.0 kgs.	2 pcs.	4.32m <sup>2</sup>
800x1600mm	9 mm	53.0 kgs.	2 pcs.	2.56m <sup>2</sup>
800x3000mm	15 mm	85.0 kgs.	1 pcs.	2.40m <sup>2</sup>
800x2400mm	15 mm	70.0 kgs.	1 pcs.	1.92m <sup>2</sup>

## TECHNICAL SPECIFICATION FOR FULLBODY



CHARACTERISTIC	STANDARD AS PER ISO13006:2018/ EN14411 Gr.Bla	STANDARD AS PER IS 15622:2017 Gr.Bla	MEAN VALUE OF AGL	METHOD OF TESTING
<b>Regulatory Properties</b>				
Deviation in Length and Width	±0.30 % (±1.00 mm)	±0.10 %	± 0.10 %	ISO 10545-2/IS 13630-1
Deviation in Thickness	±5.0 % (± 0.50 mm)	±5.0 %	± 5.0 %	ISO 10545-2/IS 13630-1
Straightness in Side	±0.30 % (± 0.80 mm)	±0.10 %	± 0.10 %	ISO 10545-2/IS 13630-1
Rectangularity	±0.30 % (±1.50 mm)	±0.10%	± 0.10 %	ISO 10545-2/IS 13630-1
Surface Flatness Central Curvature	±0.40 % ( ± 1.80 mm)	±0.50 %	± 0.20 %	ISO 10545-2/IS 13630-1
Surface Flatness Edge Curvature	±0.40 % ( ± 1.80 mm)	±0.50 %	± 0.20 %	ISO 10545-2/IS 13630-1
Surface Flatness Warpage	±0.40 % (± 1.80 mm)	±0.50 %	± 0.10 %	ISO 10545-2/IS 13630-1
Surface Quality	>95% defects free	>95% defects free	>95% defects free	ISO 10545-2/IS 13630-1
Small Color Difference	ΔE <1.00	N.A.	ΔE <0.80	ISO 10545-16
Glossiness ( For Plain Colour)	As per Manufacturer	As per Manufacturer	≥ 90	Gloss Meter 60°
Glossiness (Satin)	As per Manufacturer	As per Manufacture	7 ≤ Gloss Value ≤ 25	Gloss Meter 60°

### Structural Properties

Water Absorption	≤0.50 %	≤0.080 %	≤0.080 %	ISO 10545-3/IS 13630-2
Bulk Density	As per Manufacturer	Min 2.20 g/cc	> 2.25 gm/cc	ISO 10545-3/IS 13630-2

### Massive Mechanical Properties

Modulus of Rupture	Min. 35.0 N/mm <sup>2</sup>	Min. 35.0 N/mm <sup>2</sup>	Min. 40.0 N/mm <sup>2</sup>	ISO 10545-4/IS 13630-6
Breaking Strength Thickness ≥7.5 mm	Min 1300.0 N	Min 1300.0 N	Min 6000.0 N	ISO 10545-4/IS 13630-6

### Surface Mechanical Properties

Mohs Hardness #	As per Manufacturer	Min. 5	Polished Min 4**/ Satin & Posh Min 6	BS EN 15771/IS 13630-13
Surface Abrasion Resistance #	As per Manufacturer	Min. Class II	Polished Min II**/ Satin & Posh Min III	ISO 10545-7/IS 13630-11

### Thermal Hygrometric Properties

Moisture Expansion	Max 0.06% (0.6 mm/m)	Max 0.02 mm/m	Max 0.02 mm/m	ISO 10545-10/IS 13630-3
Thermal Expansion(COE) at 100°C	As per Manufacturer	Max. 6.0 x 10 <sup>-6</sup>	Max. 6.0 x 10 <sup>-6</sup>	ISO 10545-8/IS 13630-4
Thermal Shock Resistance	Min 10 Cycle	Min 10 Cycle	Min 10 Cycle	ISO 10545-9/IS 13630-5
Impact Resistance(COR) #	Min. 0.55	Min 0.55	Min 0.55	ISO 10545-5/IS 13630-14
Frost Resistance	As per Manufacturer	As per Manufacturer	Frost Proof	ISO 10545-12/IS 13630-10
Crazing Resistance at 7.5 bar	4 Cycle	4 Cycle	4 Cycle	ISO 10545-11/IS 13630-9

### Chemical Properties

Resistance to Staining Glazed	Min. Class 3	Min Class 1	Min. Class 3/Min. Class 1	ISO 10545-14/IS 13630-8
Resistance to Household Chemicals & Swimming Pool Salts Glazed	Min Class GB	Min Class AA	Min Class GB/Min Class AA	ISO 10545-13/IS 13630-8
Resistance to Low Concentrate Acid and Alkalis Glazed	As per Manufacturer	As per Manufacturer	Min Class GLB***/ Min Class A***	ISO-10545-13/IS 13630-8
Resistance to High Concentrate Acid and Alkalis Glazed	As per Manufacturer	As per Manufacturer	Min Class GHB***/ Min Class A***	ISO-10545-13/IS 13630-8

### Safety Properties

Skid Resistance - (DCOF-WET PENDULUM)##	As per Manufacturer	As per Manufacturer	Glossy ≥P0,Satin, Posh ≥P1	BS 7976-2
Slip Resistance -Satin/Posh (DCOF- R Value )##	As per Manufacturer	As per Manufacturer	R9 to R10	DIN 51130
Lead and Cadmium release	As per Manufacturer	N.A.	Does not yield Pb &Cd	ISO-10545-15

\* Whichever is Lower | \*\* With nano technology (Polished Vitrified tiles) Depending on Application area (low or high intensity of traffic)  
\*\*\* Except Hydrofluoric Acid & it's compound | # Tiles Intended for use on floor | ## For floor tiles, as per customer requirement

## PACKING SPECIFICATION

Size (mm)	Thickness (mm)	Weight (Kg.)	No. of Tiles / Set	Area Sq. mtr./ Box
800x1600mm	9 mm	53.0 kgs.	2 pcs.	2.56m <sup>2</sup>
800x3000mm	15 mm	85.0 kgs.	1 pcs.	2.40m <sup>2</sup>
800x2400mm	15 mm	70.0 kgs.	1 pcs.	1.92m <sup>2</sup>

## SLAB LAYING

Tools suggested for Laying

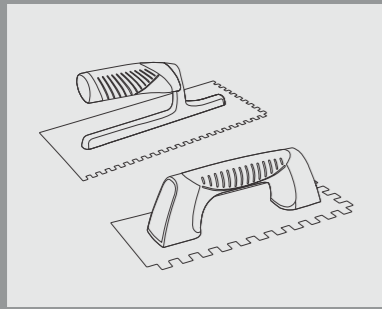

3mm & 10mm trowel

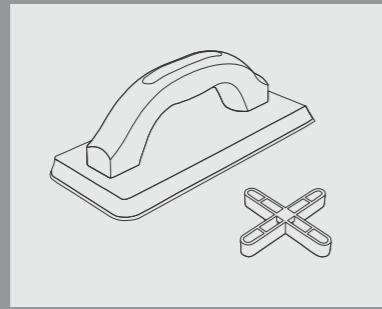

Rubber trowel & Spacers

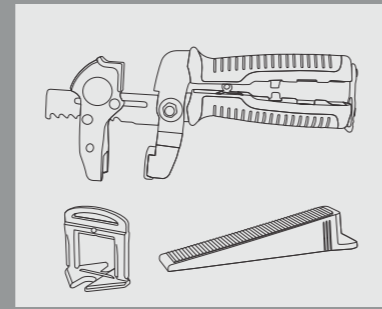

Device for plate's pulling over and Leveling wedges & clips

## SLAB LAYING INSTRUCTIONS

Check the laying substrate. Make sure it is clean, mature, and homogeneous with no cracks.

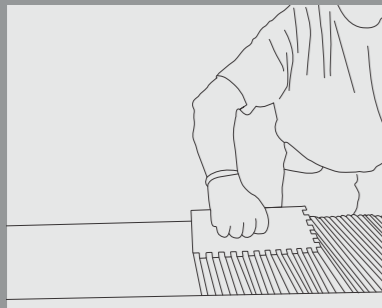

Apply adhesive onto the back of the slab with a 3mm trowel in one direction only.

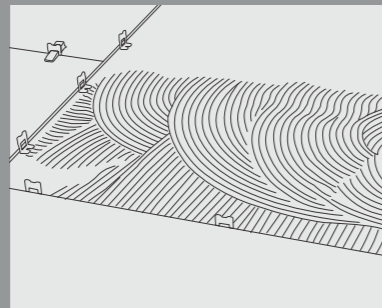

Apply adhesive onto the floor substrate at the same time while applying on the slab with a 15mm U-notch or 19mm V-notch trowel in the same direction as the slabs.

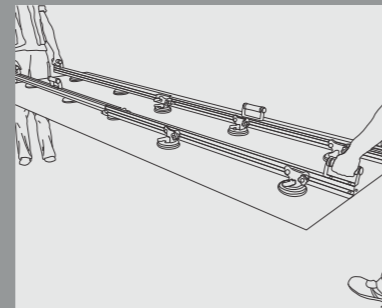

Position the slab on the adhesive bed with a sucker frame with adjustment of a minimum of 3mm joint.

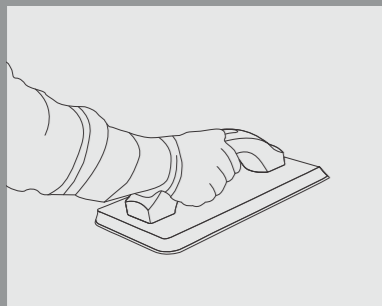

Tap the slab from the center to the edges with a rubber trowel to expel air. Make sure air is expelled and there is no bubble between the slab and the substrate.

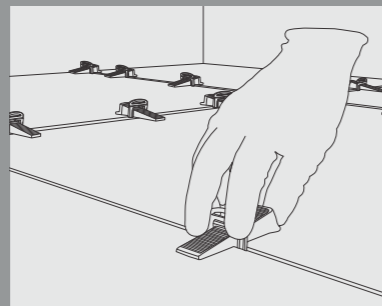

Complete the laying of the slab with a suitable sealant while keeping a 3mm joint through spacers. The special device of pulling over the slabs can be used for easy laying and spacing.

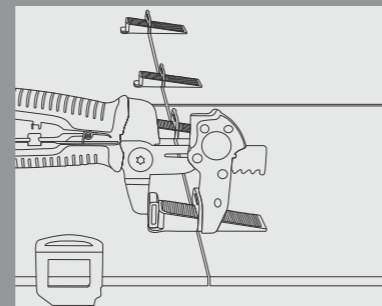

Level the wedges at each linear meter of the slab.

## SLAB EDGE POSSIBILITIES

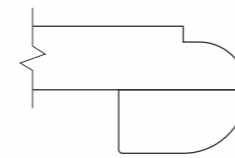

1-1/2" Dupont Bullnose

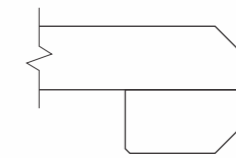

1-1/2" Pencile Edge

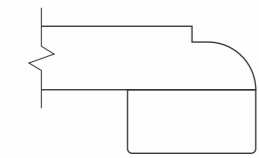

1-1/2" Dupont Square

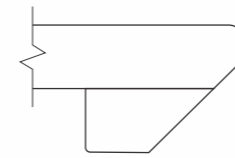

1-1/2" Revers Bevel

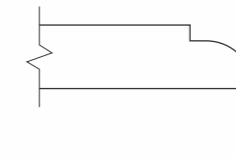

3/4" Dupont Demi

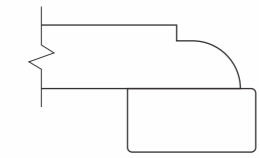

1-1/2" Dupont Step Square

## CLEANING & MAINTENANCE

High-quality raw materials, rigorous production parameters, and world-class technology at AGL make the exclusive offering nonporous and thus no dust or deposited waste penetrates the surface.

The no-maintenance surfaces require only a damp cloth for cleaning.

Routine and recurring cleaning spotlights the aesthetic features of the surfaces and keeps the surfaces shining.

For cleaning contamination and stains caused by some common food and other material follow the table below:

TYPE OF STAIN	CHEMICAL PRODUCT	EXAMPLE
Grease	Alkaline - Solvent	Detergent
Oil	Solvent	Ammonia, Baking Soda
Ink	Oxidant - Solvent	Alcohol, Liquid Bleach, Nail Paint Remover
Rust	Acid	Hydrochloric Acid, Vinegar, Red Harpic
Lime	Acid	Descaling Reagent, Hydrochloric Acid
Cement	Acid	Hydrochloric Acid
Wine	Alkaline	Ammonia, Liquid Bleach
Coffee	Alkaline - Solvent	Ammonia, Liquid Bleach
Rubber	Solvent	Alcohol, Thinner
Plaster	Acid	Hydrochloric Acid
Candle Wax	Solvent	Alcohol, Thinner
Iodine	Oxidant	Liquid Bleach
Blood	Oxidant	Liquid Bleach
Ice Cream	Alkaline	Liquid Bleach

**Note:** It is recommended that any kind of stain needs to get clean immediately / as soon as possible.

## CORPORATE OFFICE & BRANCHES

### DISPLAY CENTRE & OFFICE

#### GUJARAT

■ **Display Centre - Ahmedabad**  
**AGL Luxury Tile Arcade**  
 S.G. Highway, Nr. Gota Cross Road,  
 Beside Gota over bridge, Ahmedabad - 382481.  
 Mobile: 98258 03713 / 99099 29920  
 E-mail: asianworld.amd@aglasiangranito.com

■ **AGL Export House - Morbi**  
 Ch-5, Eden Ceramic City,  
 Opp.Honest Hotel, National Highway,  
 Lalpar Road Morbi - 363642.  
 Mobile: 99799 90591  
 E-mail: exportmorbi@aglasiangranito.com

■ **AGL Showroom**  
**Future Ceramic Private Limited**  
 Servey No.-84P1, 84P2, 85/1, 85/2P1, 85/2P2  
 B/h Harikrupa Papers LLP,  
 8-A NH, At Post Gala - Morbi -363642  
 Mobile: 93166 32661

■ **Factory Display Centre - Morbi**  
**(Sanitaryware & Faucets)**  
**AGL Sanitaryware Pvt. Ltd.**  
 Survey No. 153 P1, 153 P2, 154 P2, 8A National  
 Highway, B/h. Bahadurgadh Bus Stand,  
 At. Bahadurgadh, Morbi-363642. Gujarat, India.  
 Mobile: 93166 32908  
 E-mail: export34@aglasiangranito.com

#### MAHARASHTRA

■ **AGL Display Centre - Mumbai**  
 A- 402, Citi Point, Nr. kohinoor Hotel,  
 Opp. ICICI Bank, J.B. Nagar,  
 Chakala Metro Station, Andheri (East),  
 Mumbai - 400 059.  
 Mobile: 93214 95229  
 E-mail: mumbaishowroom@aglasiangranito.com

■ **AGL Display Centre - Mumbai**  
**(Marblex & Grestek)**  
 Gala Impecca, Gr. Floor, Mathuradas Vasanji Rd,  
 Next to Caurtyard Marriott, J. B. Nagar,  
 Kurla-Andheri Road, Andheri (East) - 400059  
 Mobile : 7600098595

■ **AGL Display Centre - Pune**  
 Capital Square, 1st & 2nd floor, Plot No.5,  
 Nr. Laxminarayan Sweets, Industrial Estate,  
 Mukund Nagar, Pune - 411037 Maharashtra.  
 Mobile : 93717 65505

#### TELANGANA

■ **AGL Display Centre - Hyderabad**  
**(Marblex & Grestek)**  
 202 Kurve Elite, 2nd Floor, 8-3-833/58 & 47,  
 Plot No. 58, Phase-1, Kamala Puri Colony Main Rd,  
 Opp. Krishe Meadows, Hyderabad-500073  
 Mobile: 96420 00336 / 77779 15632  
 E-mail: hydgv1@aglasiangranito.com

■ **AGL Display Centre - Hyderabad**  
 # 8-2-294/82, Plot No. 39, Road No. 5,  
 Jubileehills Land Mark, Near Venkatagiri Bustop.  
 (Dominos Pizza) Metro Pillar No.3,  
 Hyderabad-500033  
 Mobile: 96420 11146  
 E-mail: hydshowroom@aglasiangranito.com

#### KARNATAKA

■ **AGL Display Centre - Bangalore**  
**Asian Granito India Ltd., Region Office**  
 Brahmananda Court, No.37/17, Nr. ICIC Bank,  
 Lalbagh Road, Bangaluru - 560027 Karnataka  
 Mobile: 81605 21204  
 E-mail: bangloreshowroom@aglasiangranito.com

#### KERALA

■ **AGL Display Centre - Kochin**  
 No.51/2910 D2 Adjacent To Bread World,  
 Thykoodam Bridge Service Road,  
 Vyttila Kochin - 682019  
 Mobile: 80866 61920 / 78618 09641  
 E-mail: cochinshowroom@aglasiangranito.com

#### WEST BENGAL

■ **AGL Display Centre - Kolkata**  
 5th Floor, Office No. 5A, PS SOLARIS Building,  
 113/H, Opp. Flaming Hospital. Matheswartala Rd.  
 Topsia. Kolkata 7000046.  
 Mobile: 85840 65565  
 E-mail: kolkattashowroom@aglasiangranito.com

#### UTTAR PRADESH

■ **AGL Display Centre - Noida**  
 F-15, Ground Floor, Sector 8,  
 Gautam Buddha Nagar,  
 Noida - 201301 Uttar Pradesh  
 Mobile: 85111 30500



Scan for  
360° Tour

### OFFICE

#### GUJARAT

■ **Corp. Office - Ahmedabad**  
**ASIAN GRANITO INDIA LTD.**  
 202, Dev Arc, Opp. Iskcon Temple,  
 S. G. Highway, Ahmedabad - 380 015  
 Gujarat (INDIA)  
 Phone: +91 79 66125500/698  
 Toll Free: 1800 123 3455  
 E-mail: info@aglasiangranito.com

■ **AGL Office - Morbi**  
 B - 26, Parshwanath Complex-1  
 Opp. kuber Cinema, 8-A National Highway,  
 Lalpar Road, Morbi - 363642.  
 Mobile: 9825802077  
 E-mail: aglmorbi@aglasiangranito.com

#### RAJASTHAN

■ **AGL Office - Jaipur**  
 Lower Ground, D-5, Vaishali Nagar,  
 Jaipur, Rajasthan - 302021  
 Mobile: 80085 03660 / 93144 39930

#### MADHYA PRADESH

■ **AGL Office - Indore**  
 3rd Floor, Plot No 101, WB Scheme No. 94,  
 Sector - B, Opp. HDFC Bank, Nr. Bombay Hospital,  
 Indore - MP - 452010  
 Mobile: 99092 62533 / 73140 06670  
 E-mail: acctsindore@aglasiangranito.com

#### TAMIL NADU

■ **AGL Office - Trichy**  
 Mark Diamond Residency, No-36,  
 V O C Road, cantonment. Trichy - 620001  
 Mobile: 90161 13976

#### AGL Office - Coimbatore

No .70, Dr. Alagappa Road, Tatabad.  
 Coimbatore - 641 012  
 Mobile: 90161 13976

#### ODISHA

■ **AGL Office - Odisha**  
 Plot No-83/C, Jayadurga Nagar Bomikhal,  
 Bomikhal, Cuttack-Puri Road,  
 Bhubaneswar-751006  
 Mobile: 78618 09594 / 78944 35425

#### PUNJAB

■ **AGL Office - Chandigarh**  
 CCC Chandighar City Centre, Block A 3rd Floor,  
 Soho 325, Vip Road, Near Metro Zirakpur,  
 Chandigarh Punjab-140603  
 Mobile : 93163 13880 / 99882 22471

