



Kajaria
VITRONITE

800x2400mm | 15mm

FULL BODY VITRIFIED SLAB

Kajaria





Only ceramic tile company in India to be conferred with "superbrand" for the twelfth time in a row.

WE PURSUED EXCELLENCE, LEADERSHIP FOLLOWED



Awarded Asia's Most promising brand.

Kajaria Ceramics is the largest manufacturer of Ceramic/Vitrified tiles in India. It has an annual capacity of 70.40 mn. sq. meters, distributed across eight plants.

The motivating factor remains the zeal to be the best, to be at the top and to achieve the highest echelons of excellence.



Certified member of Indian Green Building Council

The manufacturing units are equipped with cutting edge technology. Intense automation, robotic car application and a zero chance for human errors are just few reasons why Kajaria remains at the top in the industry.

The best in providing tile solutions, Kajaria has since then grown stronger with its hard work, innovation and patronage from our discerning customers.

AWARDS & ACCOLADES

- ISO 9001:2008 Certification for Implementing a Quality Management System.
- ISO 14001 Certification for Implementing an Environmental Management System.
- ISO 22000:2005 Certification for Implementing a Food Safety Management System.
- ISO 50001:2011 Certification for Establishing, Implementing, Maintaining and Improving an Energy Management System.
- SA 8000 Certification for Implementing Social Accounting Standards.



PASSION AND PEOPLE

MODERN INCEPTION FOR UNIQUE PEOPLE

Express your passion in your space with the elegant and chic designs of Vitronite slabs. Let your place reflect your personality!

WHAT IS VITRONITE SLAB?

Vitronite slabs offer a great range of colours and shades of extraordinary surfaces that transforms a space into a luxurious haven.

With the versatile applications of the Vitronite slabs, they make the perfect surfaces for residential as well as commercial spaces.

These slabs are an amalgamation of classy style and urban elegance paired with modern technology.



IT'S PERFECT CHOICE FOR URBAN LIVING



HIGHLY DURABLE

Vitronite slabs are strong, highly durable and withstand heavy impacts.



DIMENSIONAL STABILITY

The Vitronite slabs are thoroughly tested for dimensional stability.



HEAT RESISTANT

Manufactured at high temperatures and are created to be resistant to heat.



STAIN RESISTANT

Designed to be stain resistant while keeping in mind the risks of stain on a surface.



LESS WATER ABSORPTION

Water resistant making it a worry-free task to clean the spills on the surface.



SCRATCH RESISTANT

The Vitronite slabs restrict scratches giving a clean look to a place.



CHEMICAL RESISTANT

Chemicals, acidic foods or drinks cannot damage the slabs.



ULTRA-VIOLET LIGHT RESISTANT

Resistant to UV rays which helps keep the colours of the surface intact without fading.

**800
x
2400
mm**



MIGHTY SURFACE FOR MIGHTY DREAMS

The grand size of Vitronite slabs gives a spacious and luxurious look to a place.

EDGE PROFILE

The vitronite slabs offer various edge profiles that are made possible with their 15mm thickness. The different edges give a stylish and modern appeal to these surfaces.



EASED EDGE

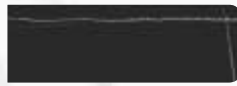

1/2" ROUND TOP & BOTTOM



1/4" BEVEL



1/4" BEVEL TOP & BOTTOM



DEMI BULLNOSE



FULL BULLNOSE



OGEE

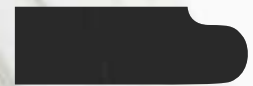

OGEE BULLNOSE



HALF BULLNOSE

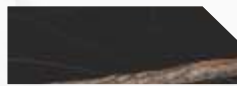

1/2" BEVEL



COVE

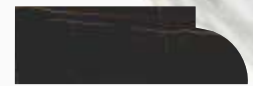

DUPONT

WHY VITRONITE IS BETTER?

FEATURES	 Kajaria VITRONITE	QUARTZ SURFACE	GRANITE	MARBLE	SOLID SURFACE
UV RESISTANCE	★★★★★	★★	★★★★	★★★★	★
FLEXIBILITY	★★★★★	★★★	★	★	★★★★★
HEAT RESISTANCE	★★★★★	★★★	★★★★	★★★★	★★★
SCRATCH RESISTANCE	★★★★★	★★★★★	★★★★	★★★★	★★★
CHEMICAL RESISTANCE	★★★★★	★★★	★★★★	★★★★	★★



NEW AGE KITCHEN TOPS FOR MODERN KITCHEN

The incredible Vitronite slabs are designed for modern applications and to create a chic and urban aura for a space.

These slabs are here to create your dream kitchen with its grand size and spectacular designs.

BOLD AND BEAUTIFUL

The Vitronite slabs are highly durable with their 15mm thickness. They give a classy appearance to a space with their glossy finish.

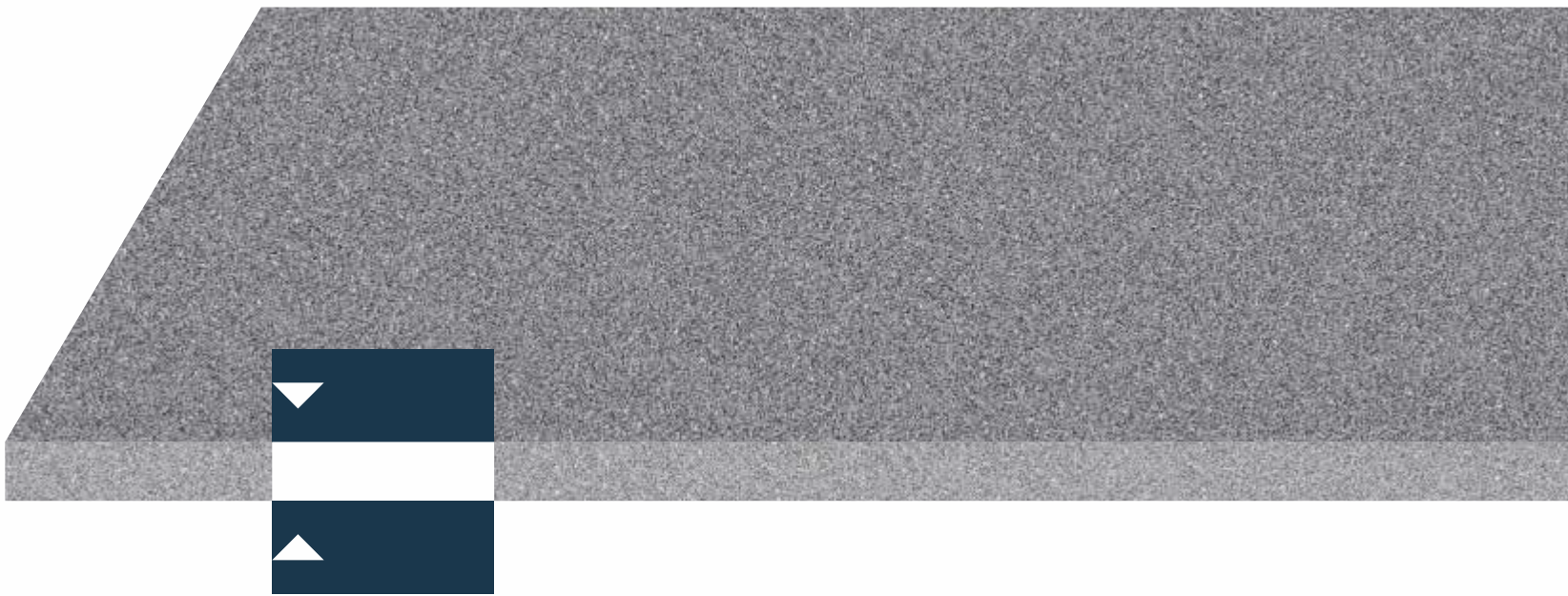

15MM
THICK
NESS

APPLICATION POSSIBILITIES

The Vitronite slabs are perfect when it comes to giving a touch of grandeur to a space. They have multiple applications for indoor as well as outdoor spaces.

Its versatile applications allow to style spaces and create an elegant ambience with rich aesthetics.





**STEP &
RISER**



**TABLE TOP &
WORK TOP**



**WINDOW
NOOK**



**VANITY
TABLE**

FULL BODY GRANITE SLAB

The full body granite slab by Vitronite comes in many different shades that bring the charm of minimal design to a space.

TERRAZZO



SALT & PEPPER



PLAIN SOLID COLOR



ITALIAN MARBLE SLAB

The Italian marble slab by Vitronite reflects the glorious beauty of Italian marbles and creates a space full of luxurious grandness.

WHITE

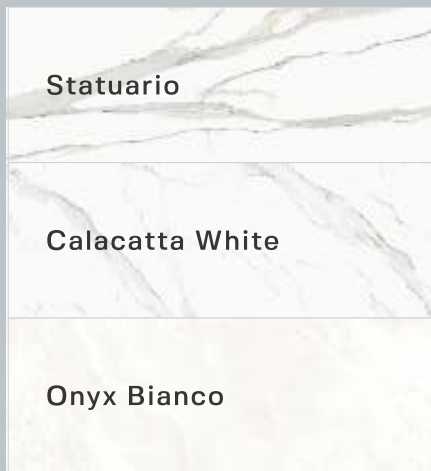

IVORY

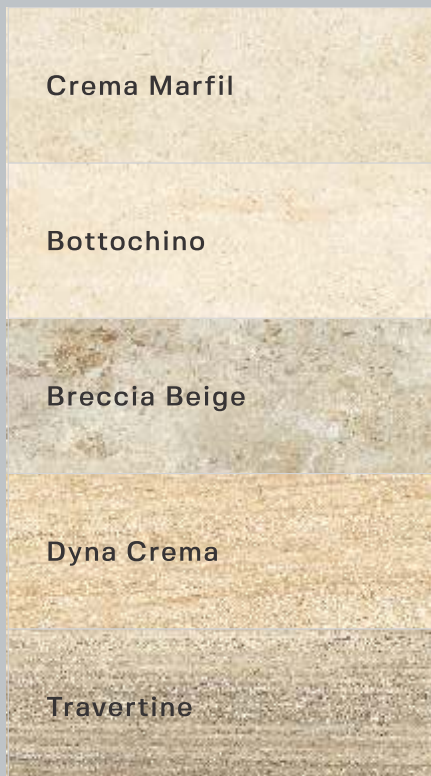

BLACK

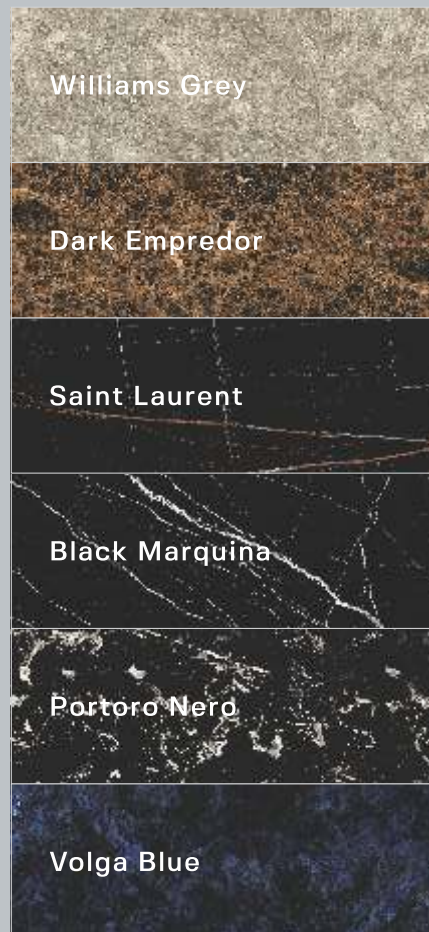

COLOR BODY

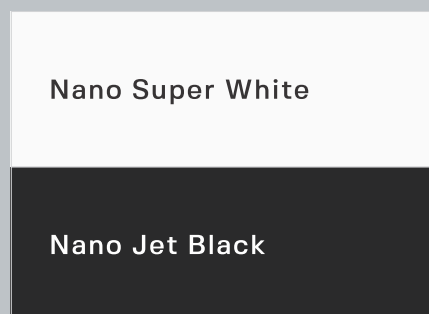

TERRAZZO



REVAMP CLASSIC FORM OF ART

Bringing alive art and designs through grand surfaces inspired by the classic masterpieces reformed with an urban touch for elegant spaces.

Kajaria
VITRONITE



**15mm
THICKNESS**

**800x
2400mm**

**FULL
BODY**



Kajaria
VITRONITE

800x2400mm
15mm THICKNESS

TERRAZZO
(FULL BODY)



TERRAZZO CREMA



800x2400mm
15mm THICKNESS

TERRAZZO
(FULL BODY)



TERRAZZO VERDE



800x2400mm
15mm THICKNESS

TERRAZZO
(FULL BODY)



TERRAZZO BROWN



800x2400mm
15mm THICKNESS

TERRAZZO
(FULL BODY)



TERRAZZO WHITE



Kajaria
VITRONITE

800x2400mm
15mm THICKNESS

TERRAZZO
(FULL BODY)

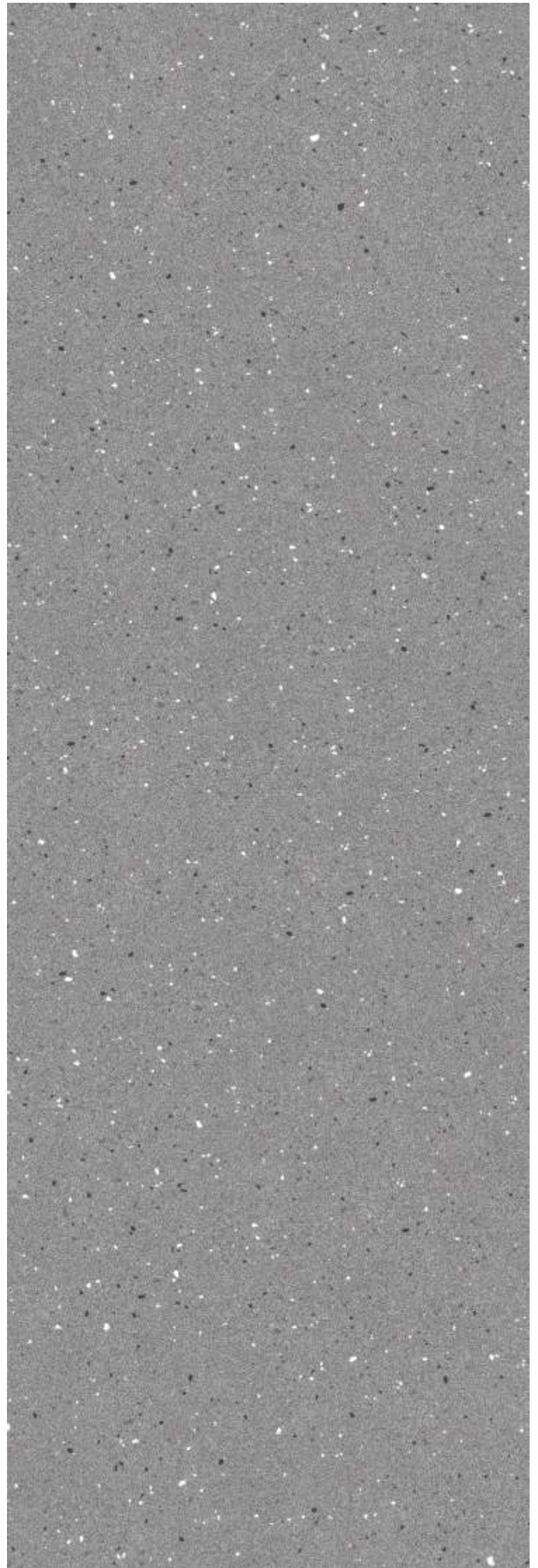

TERRAZZO GREY



800x2400mm
15mm THICKNESS

TERRAZZO
(FULL BODY)



TERRAZZO DARK GREY



800x2400mm
15mm THICKNESS

TERRAZZO
(FULL BODY)

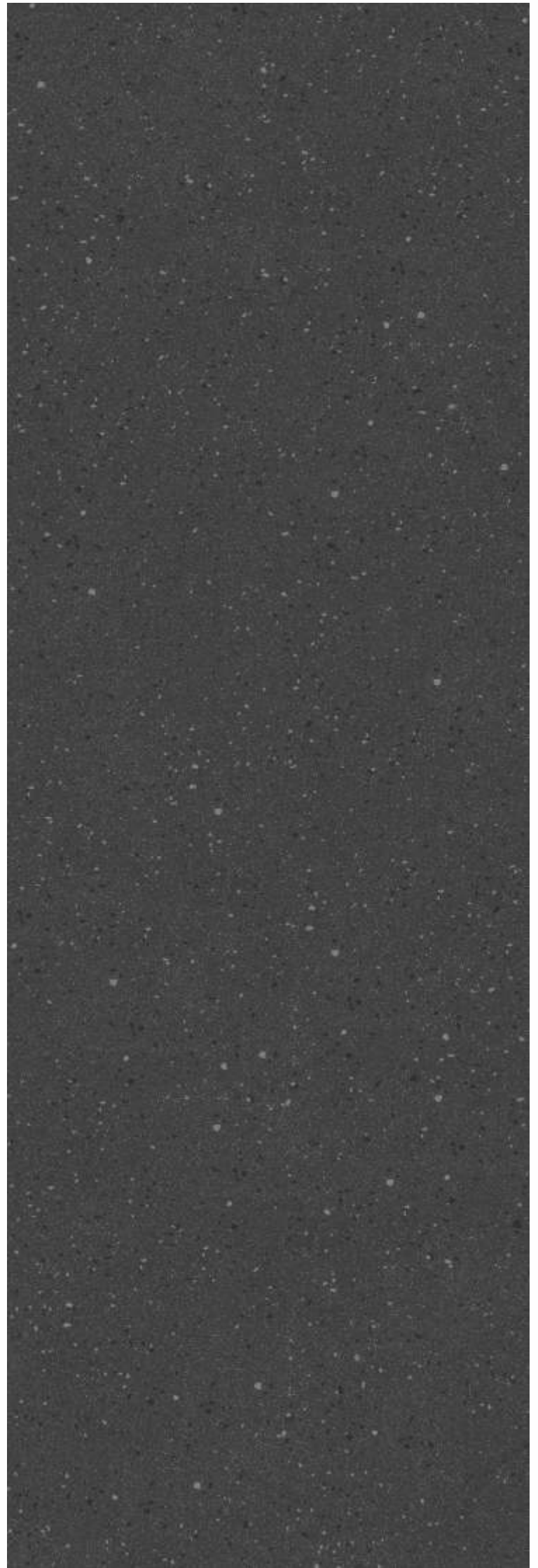

TERRAZZO BLACK

SALT & PEPPER



THE ADVENTURES OF STURDY DESIGNS

Designs that holds the essence of nature within and makes you indulge with the appearance by flourishing your space with the beauty of art in it.

VITRONITE *Kajaria*



**15mm
THICKNESS**

**800x
2400mm**

**FULL
BODY**



800x2400mm
15mm THICKNESS

SALT & PEPPER
(FULL BODY)



GALAXY WHITE



800x2400mm
15mm THICKNESS

SALT & PEPPER
(FULL BODY)



GALAXY BLACK



Kajaria
VITRONITE

800x2400mm
15mm THICKNESS

SALT & PEPPER
(FULL BODY)

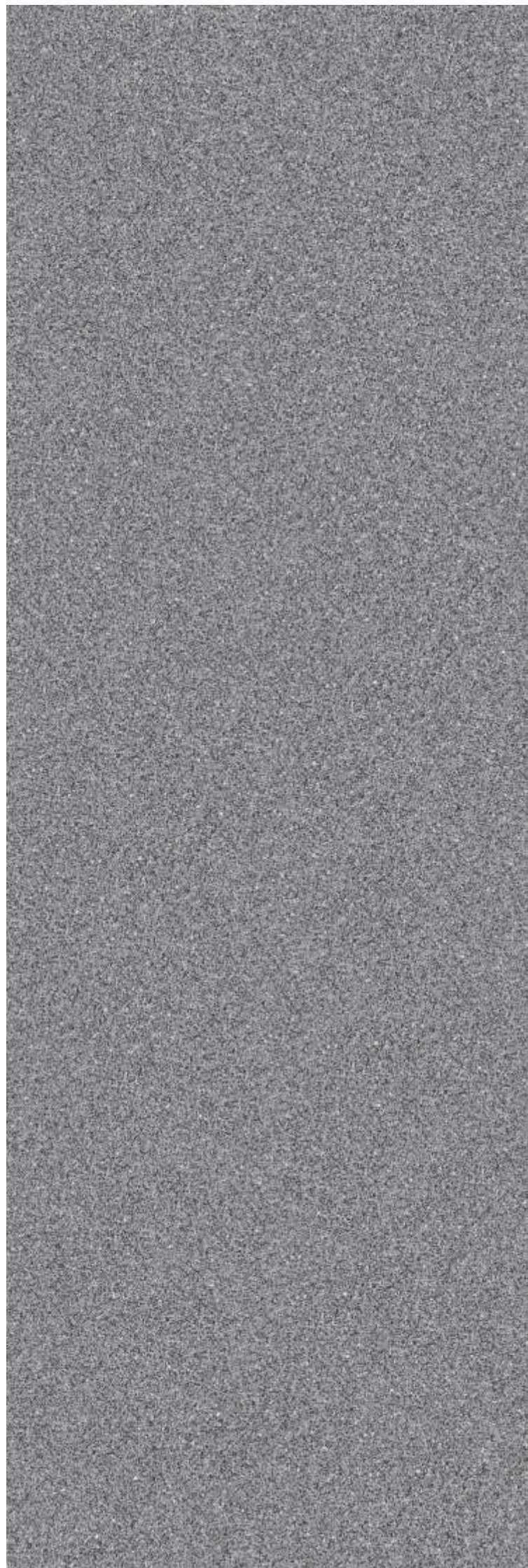

GALAXY GREY



Kajaria
VITRONITE

800x2400mm
15mm THICKNESS
SALT & PEPPER
(FULL BODY)



GALAXY CREMA

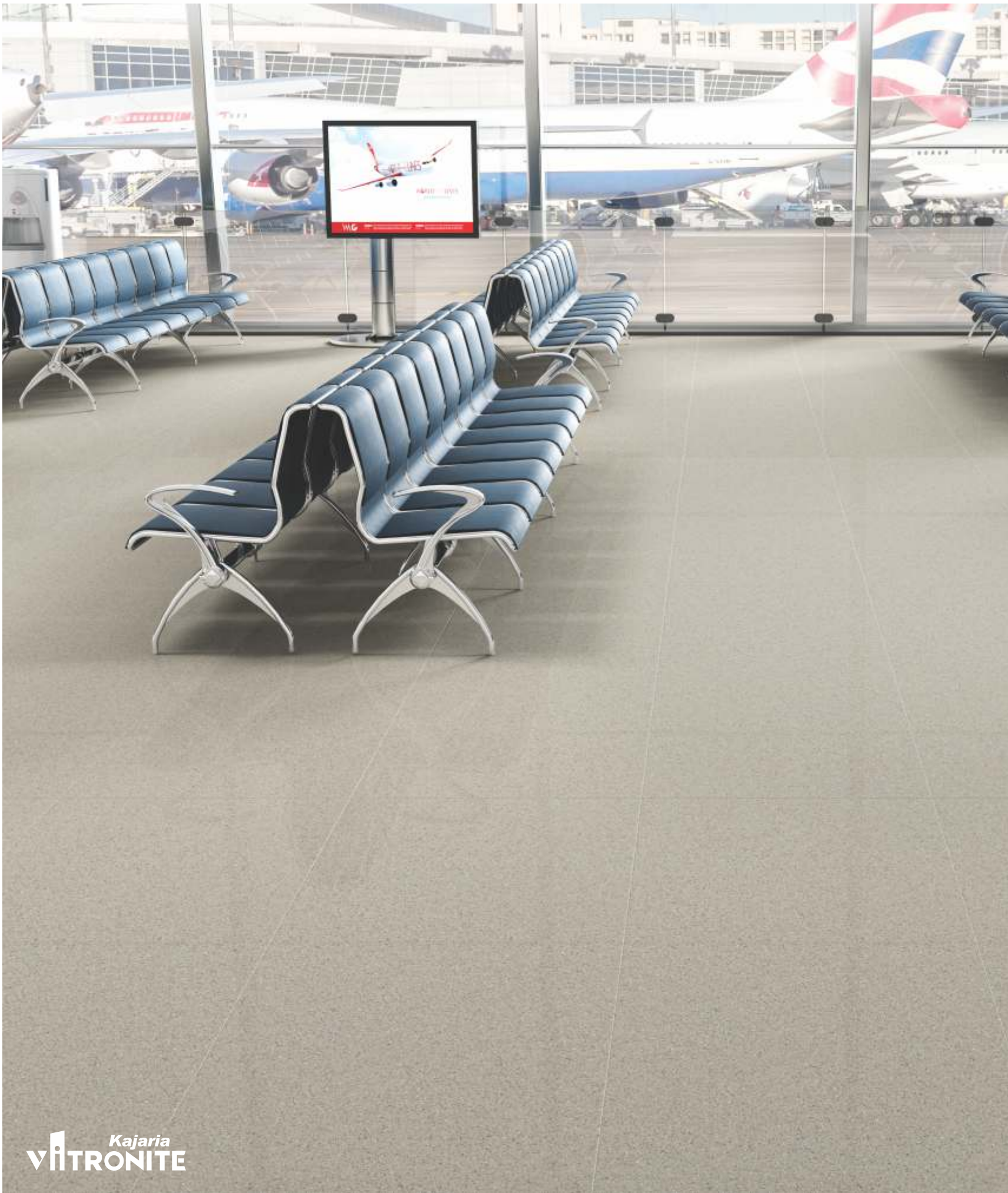

Kajaria
VITRONITE

800x2400mm
15mm THICKNESS

SALT & PEPPER
(FULL BODY)



GALAXY VERDE



800x2400mm
15mm THICKNESS

SALT & PEPPER
(FULL BODY)



GALAXY MUSHROOM



Kajaria
VITRONITE

800x2400mm
15mm THICKNESS
SALT & PEPPER
(FULL BODY)



GALAXY BROWN

ITALIAN MARBLE



EXPLORING THE RIPPLES OF CREATIVITY

Flourishing spaces with the rich appearance of simple designs, textures and colours. A prominent choice to decorate a space with an authentic look.

Kajaria
VITRONITE



**15mm
THICKNESS**

**800x
2400mm**

**MARBELITE
SERIES**



Kajaria
VITRONITE

800x2400mm
15mm THICKNESS

ITALIAN MARBLE
(WHITE BODY)

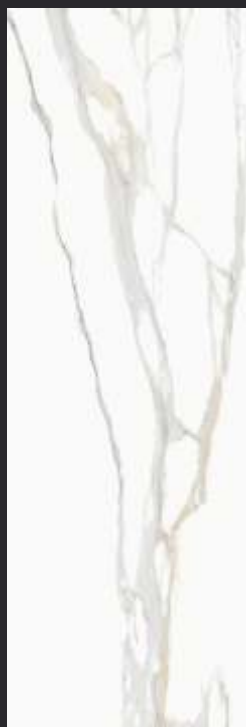
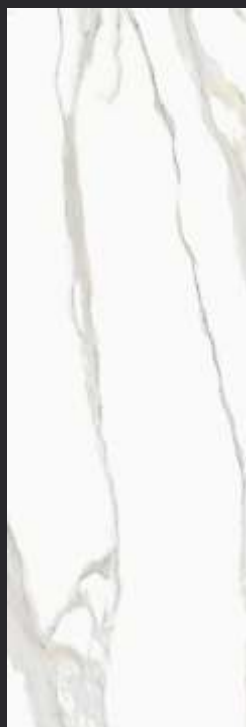

STATUARIO



Kajaria
VITRONITE

800x2400mm
15mm THICKNESS

ITALIAN MARBLE
(WHITE BODY)

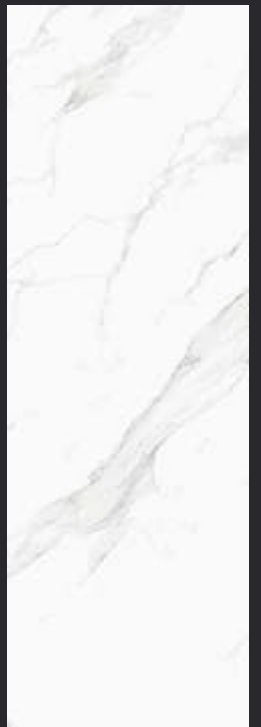
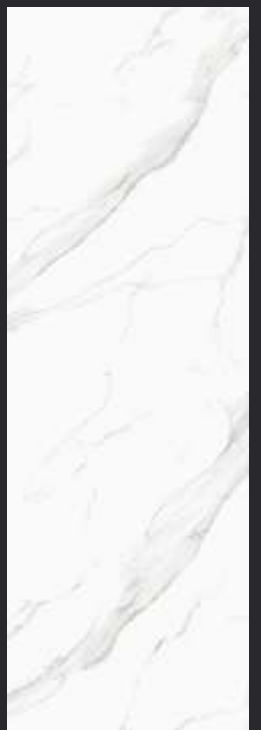

CALACATTA WHITE



Kajaria
VITRONITE

800x2400mm
15mm THICKNESS

ITALIAN MARBLE
(WHITE BODY)

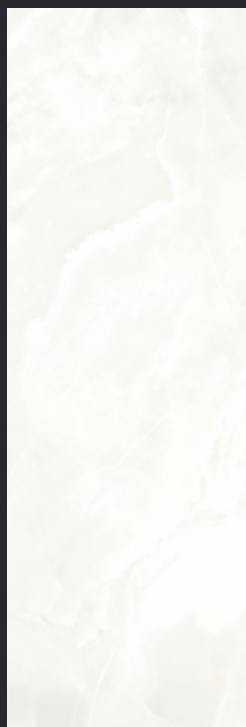
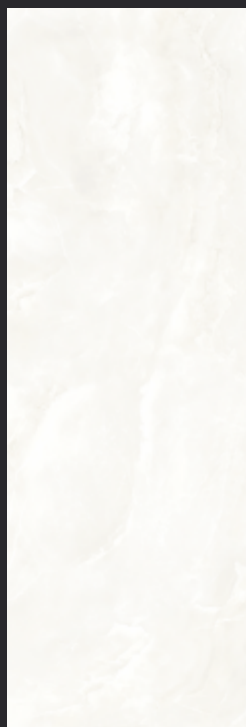
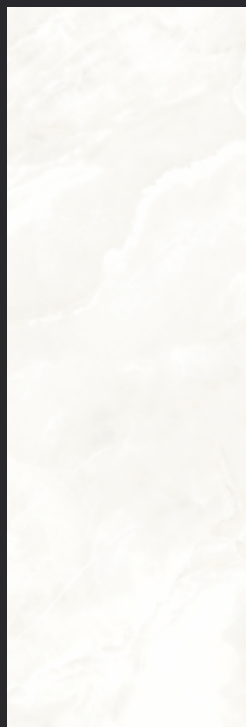

ONYX BIANCO



VITRONITE *Kajaria*

800x2400mm
15mm THICKNESS

ITALIAN MARBLE
(IVORY BODY)



CREMA MARFIL





800x2400mm
15mm THICKNESS

ITALIAN MARBLE
(IVORY BODY)

BOTTOCHINO



Kajaria
VITRONITE

800x2400mm
15mm THICKNESS

ITALIAN MARBLE
(IVORY BODY)



BRECCIA BEIGE



Kajaria
VITRONITE

800x2400mm
15mm THICKNESS

ITALIAN MARBLE
(IVORY BODY)



DYNA CREMA



Kajaria
VITRONITE

800x2400mm
15mm THICKNESS

ITALIAN MARBLE
(IVORY BODY)



TRAVERTINE



800x2400mm
15mm THICKNESS

ITALIAN MARBLE
(BLACK BODY)



WILLIAMS GREY



Kajaria
VITRONITE

800x2400mm
15mm THICKNESS

ITALIAN MARBLE
(BLACK BODY)

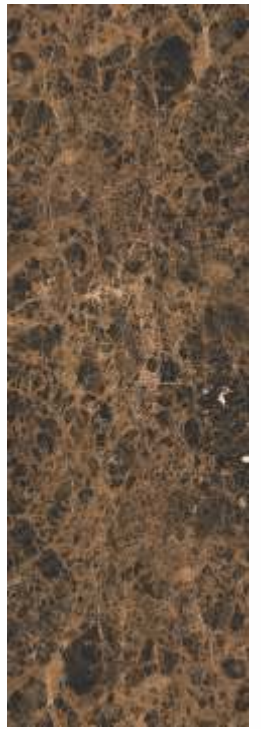
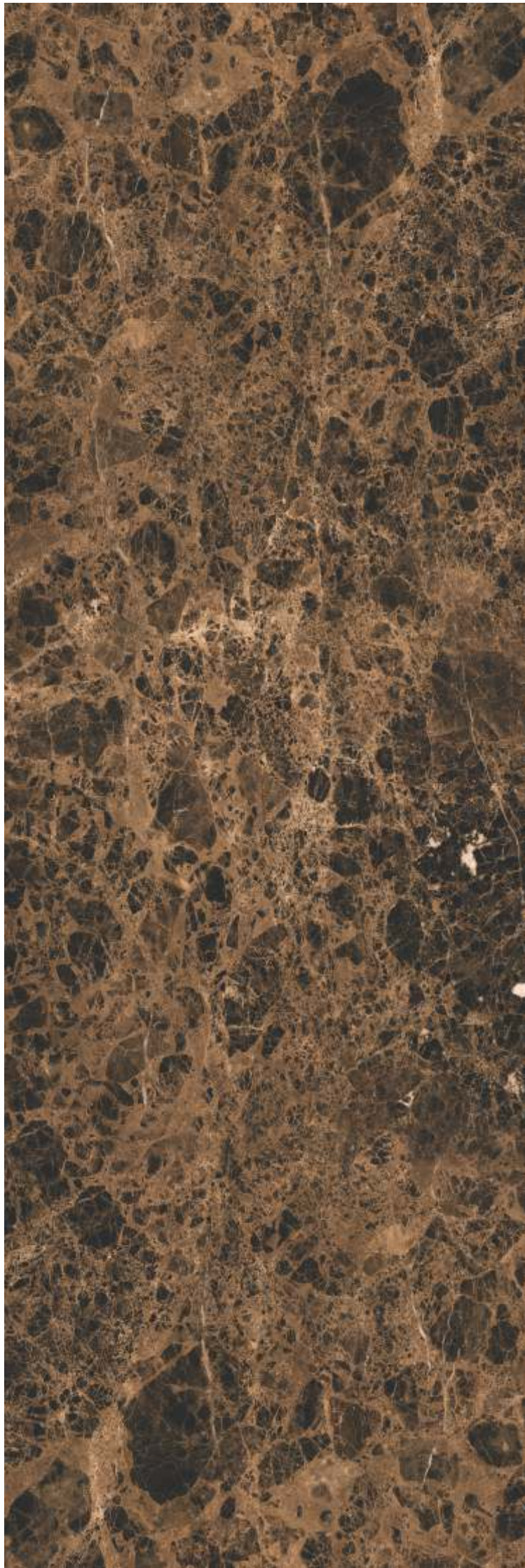

DARK EMPREDOR



Kajaria
VITRONITE

800x2400mm
15mm THICKNESS

ITALIAN MARBLE
(BLACK BODY)



SAINT LAURENT



VITRONITE *Kajaria*

800x2400mm
15mm THICKNESS

ITALIAN MARBLE
(BLACK BODY)

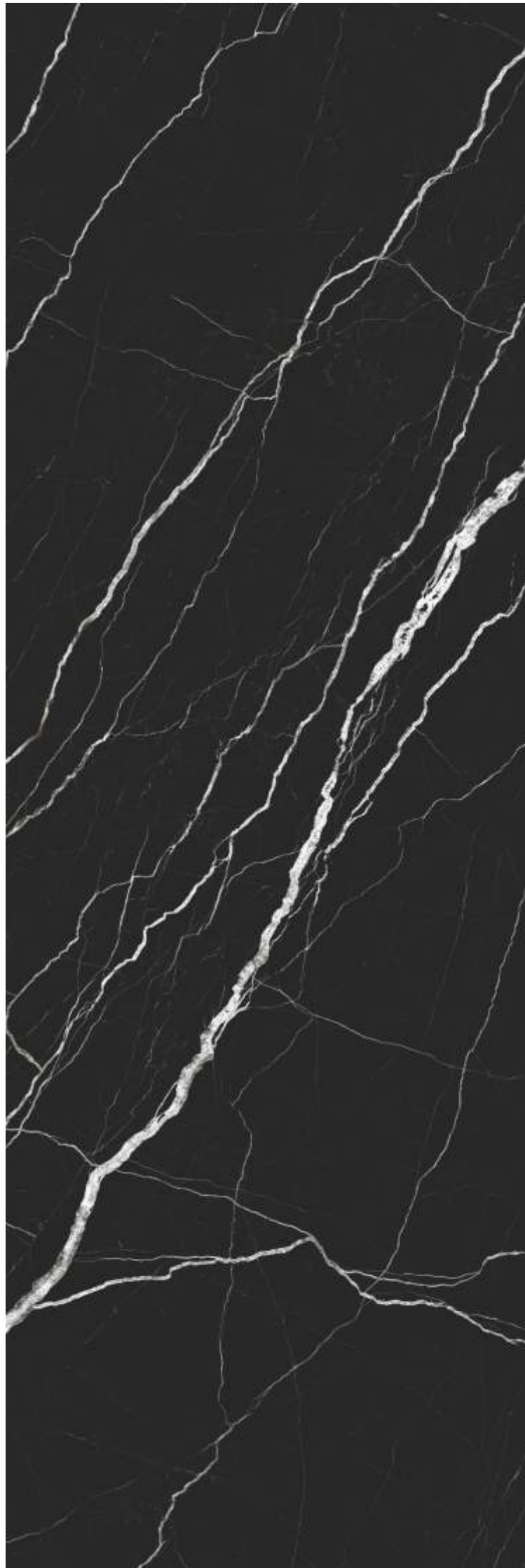

BLACK MARQUINA



800x2400mm
15mm THICKNESS

ITALIAN MARBLE
(BLACK BODY)



PORTORO NERO



800x2400mm
15mm THICKNESS

ITALIAN MARBLE
(BLACK BODY)

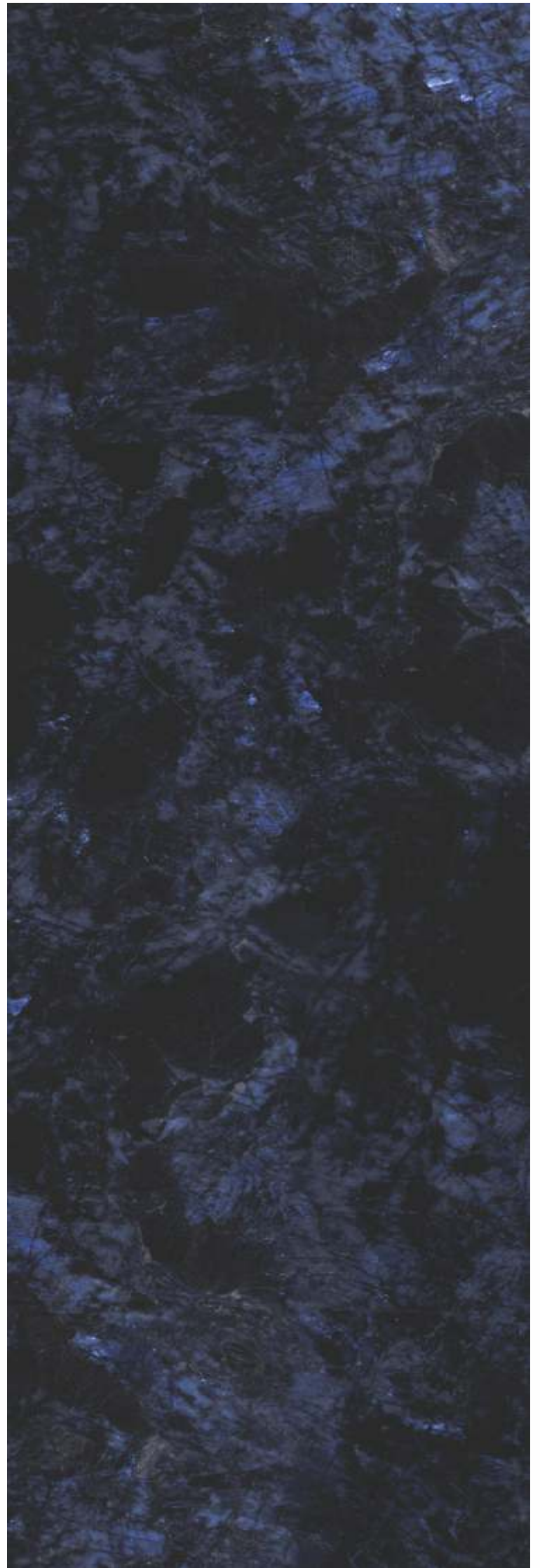

VOLGA BLUE

PLAIN SOLID COLOR



THE SERENITY AND CALM OF ART

A smart choice to bring an ultimate level of elegance and beauty to a place. It does not just give a modern look to the place but also transform the entire room decor with its charm.

VITRONITE *Kajaria*

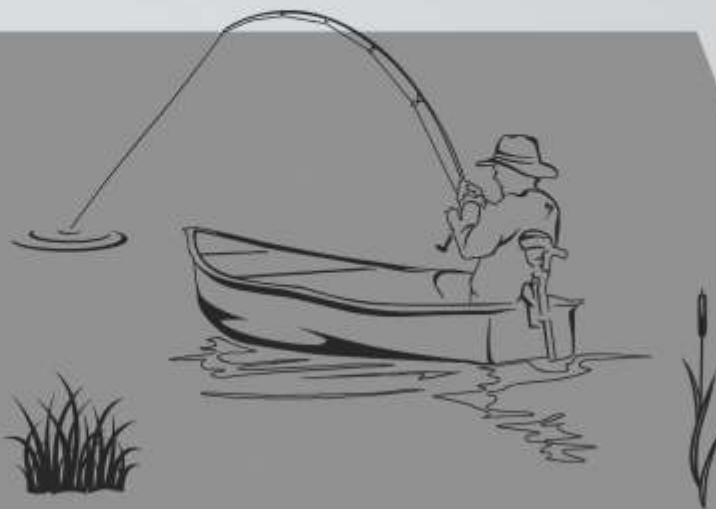

**15mm
THICKNESS**

**800x
2400mm**

**FULL
BODY**



Kajaria
VITRONITE

800x2400mm
15mm THICKNESS

PLAIN SOLID COLOR
(FULL BODY)

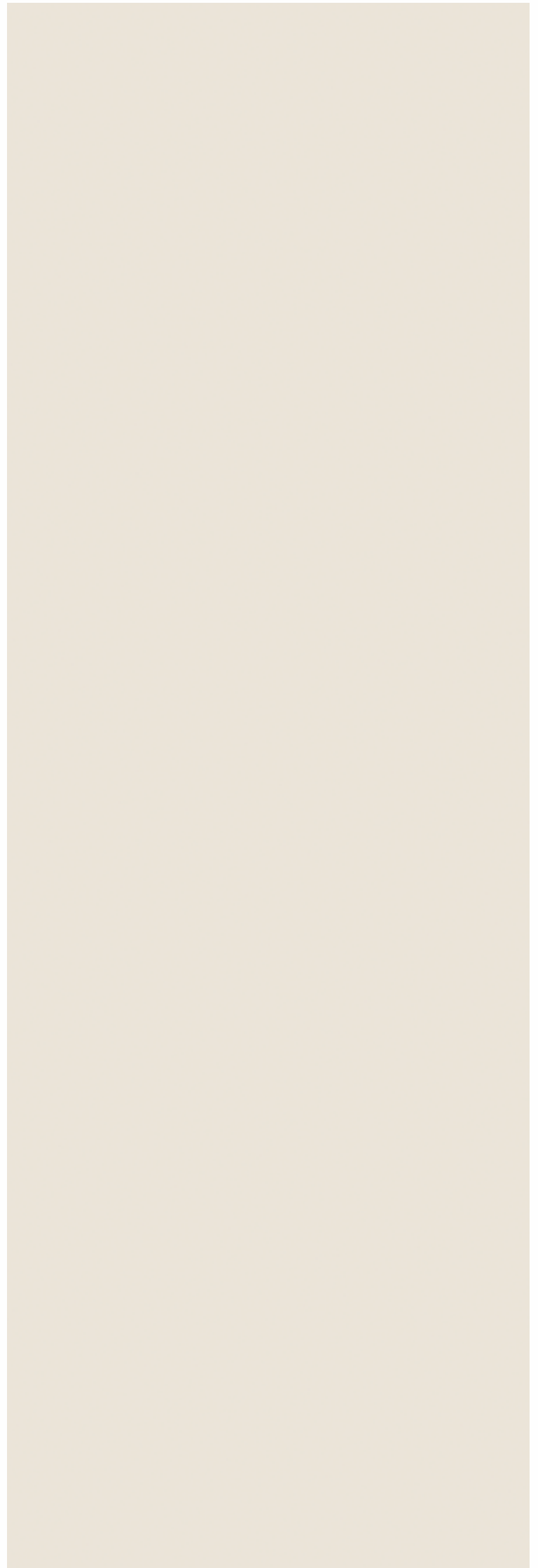

CREMA IVORY



800x2400mm
15mm THICKNESS

PLAIN SOLID COLOR
(FULL BODY)



MUSHROOM



800x2400mm
15mm THICKNESS
—
PLAIN SOLID COLOR
(FULL BODY)



BROWN



VITRONITE *Kajaria*

800x2400mm
15mm THICKNESS

PLAIN SOLID COLOR
(FULL BODY)

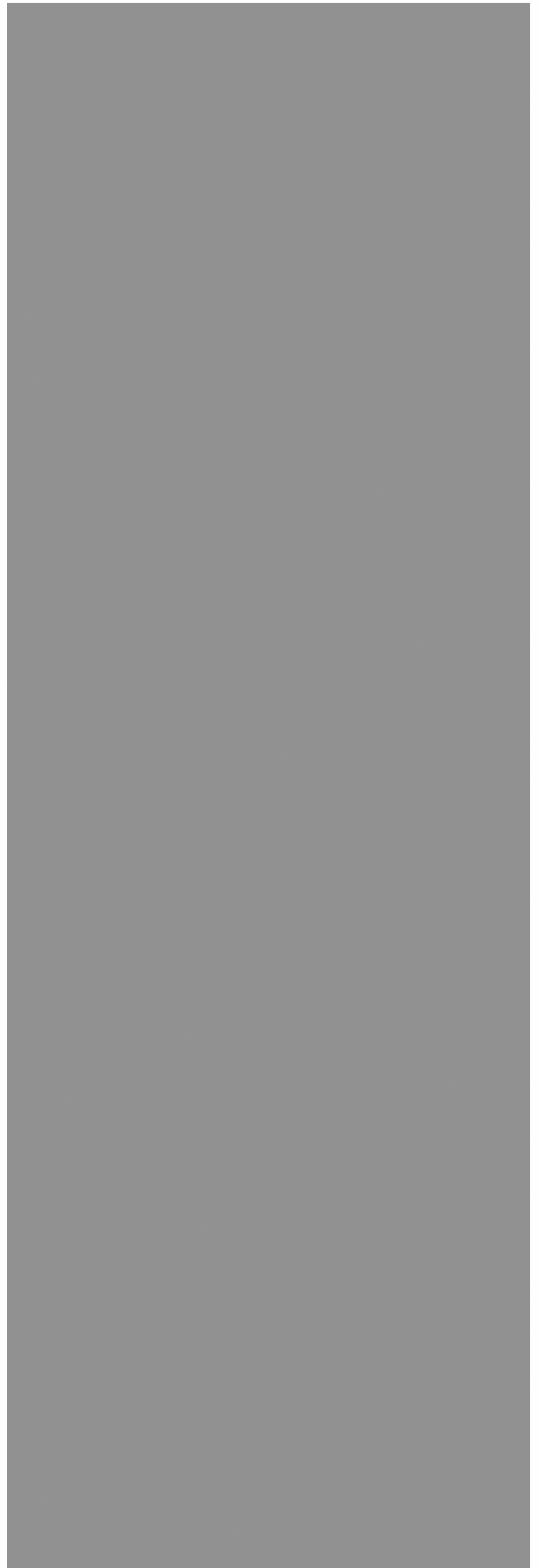

LIGHT GREY



800x2400mm
15mm THICKNESS
—
PLAIN SOLID COLOR
(FULL BODY)



DARK GREY



800x2400mm
15mm THICKNESS

PLAIN SOLID COLOR
(FULL BODY)



GRAPHITE BLACK



Kajaria
VITRONITE

800x2400mm
15mm THICKNESS

PLAIN COLOR
(COLOR BODY)

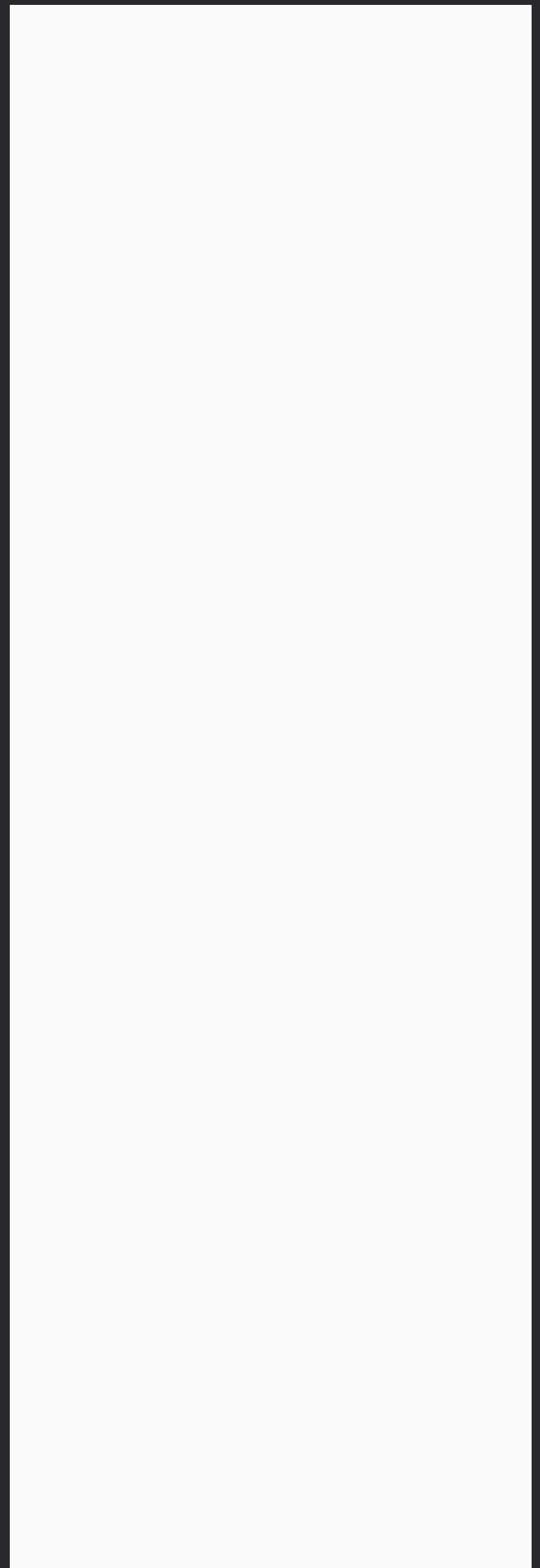

NANO SUPER WHITE



800x2400mm
15mm THICKNESS

PLAIN COLOR
(COLOR BODY)

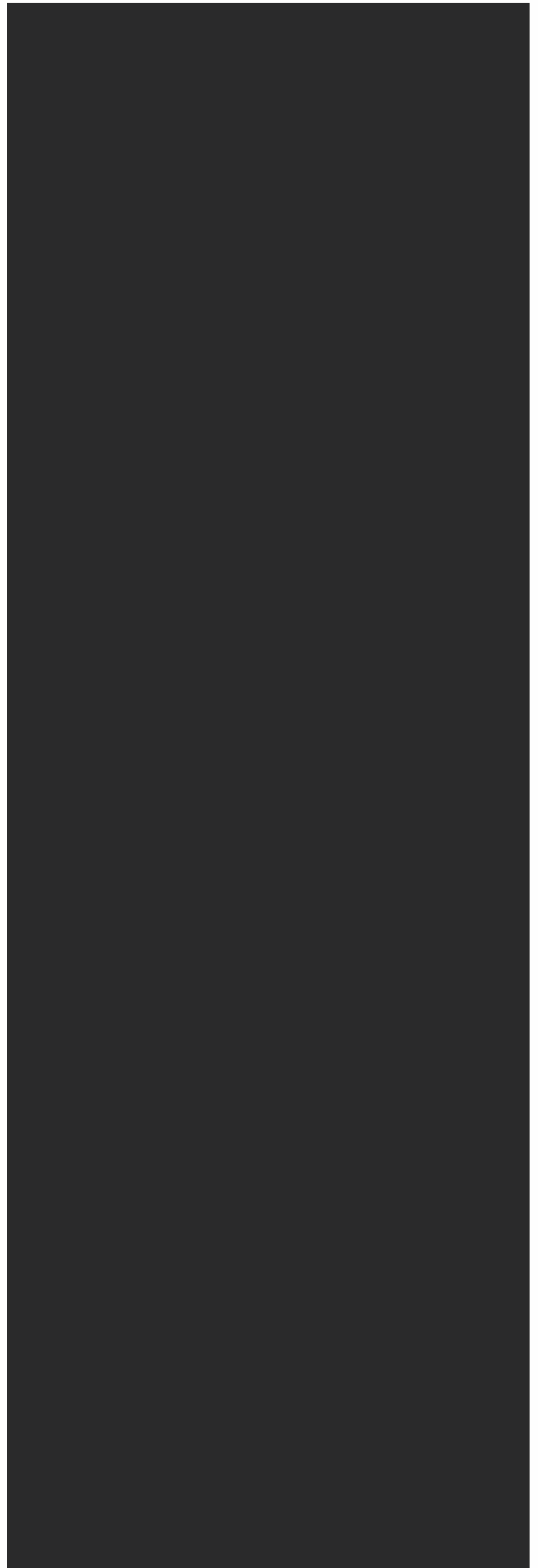

NANO JET BLACK

TRANSPORTATION & HANDLING

TRANSPORTING VITRONITE SLABS

Fig. a

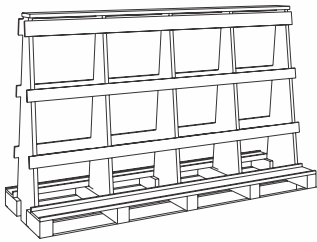

Fig. b

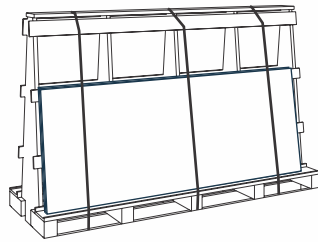
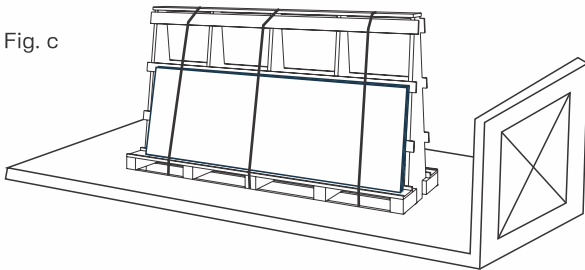

Fig. c



When transporting the Vitronite Slabs, the slabs must be secured properly to avoid storage problems. The cargo transport unit of Vitronite slabs is formed on two 'A' shaped frames for secure transportation. (Fig. a & b)

The Swedish National Road and Transportation Research Institute issued recommendations for transporting panels more than 15 years ago forming this 'A' shaped frame. No other guidance was found regarding road transportation, especially of natural stone slabs when researched from other sources. (Fig. c)

MANUALLY TRANSPORTING A VITRONITE SLAB

When transporting the Vitronite Slabs manually, the primary tool used is the regular suction cups (Fig. b). Using these, the workers can the tiles easily.

To safely and easily move the Vitronite Slabs, it is recommended that the pallet be positioned in an area where the lift truck can move around from all sides without any hindrance.

If the surface of the slab is textured, then soft rubber suction pads (Fig. a) fixed to a lifting bar should be used to ensure a strong and proper grip. The lifting bar makes it easier and more convenient to handle and transport the products without any damage. By adding rubber pads with lifting bars at the two ends of the slabs, the transportation can be performed by just two people.

However, the best way to transport the Vitronite Slabs manually is by using a rigid lifting frame (Fig. c) with suction cups that hold the tile from all four sides.

The lifting frame can be designed to match different tile sizes, formats or cut sections to keep the tile safe and protect it from any damage. This also makes the handling of tiles easy and decreases the number of people required for transporting the tile.

Possible Operations

1. To remove the tiles from the box
2. To place them on the work table
3. To carry them anywhere on the worksite
4. To spread cement-based adhesive on the underside
5. To help lay them

Fig. a



Fig. b

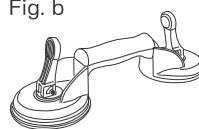
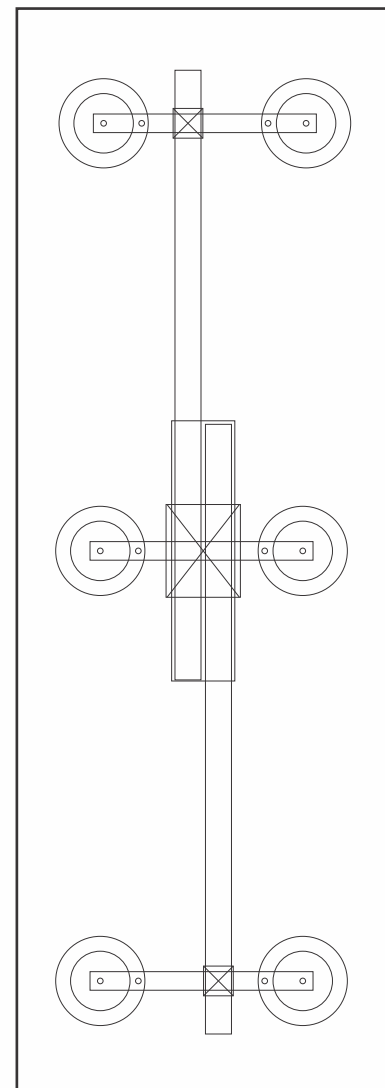

Fig. c



The suction cups should be attached to the face of the tile, not its rear side. The instructions by the manufactures should always be followed.

MANUALLY TRANSPORTING A VITRONITE SLAB

The Vitronite Slabs are very heavy, large-sized and have sharp edges. So, it is important for the people transporting it to wear protective gear like gloves while transporting the slabs. We also recommend the use of single or double suction cups for a firm grip of the tile while ensuring the safety of the operator. Before transporting the tile, it should be thoroughly cleaned to get rid of any dust and moisture and make sure the grip of the tile is not compromised. Then the suction cups should be placed on the face of the tile and checked that they stick to the surface properly before lifting the tile.

To handle the large-sized slabs like Vitronite slabs, we recommend you to use a special tile handling frame with four suction cups. In the case of small-format tiles, frames with two suction cups are sufficient.

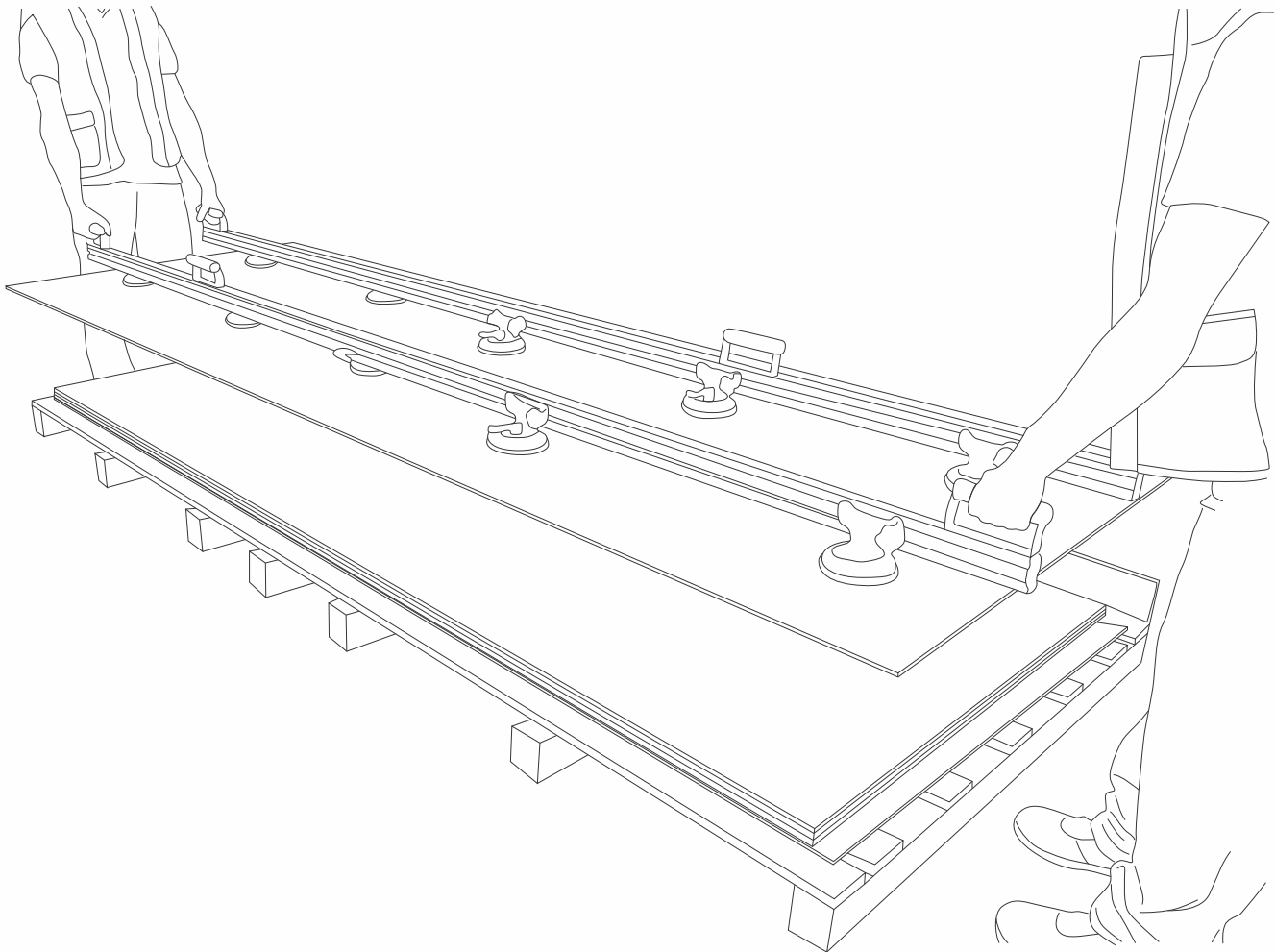

STORAGE

The supports must be able to hold the entire surface of the part during transport. Too small supports may cause the part to break:

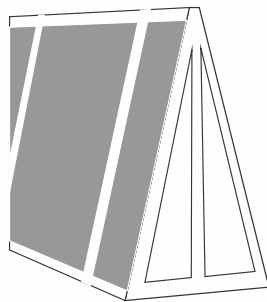
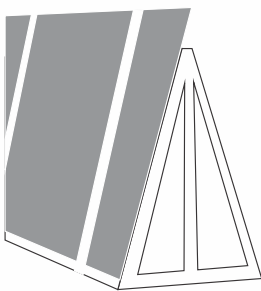

When storing the Vitronite Slabs, they must be placed length-wise on wooden beams to prevent them from splintering.

LAYING & FIXING

With the popularity of large format tiles, the tillers need to be prepared to fix the challenges that accompany them due to their weight and smooth backs.

The subfloor or the laying surface should be prepared properly before laying the tiles. The laying surface should be rigid, non-flexing and capable of supporting the expected load with minimal or no deflection. A level subfloor is extremely important to keep tiles from cracking. The subfloor can be properly leveled by using the levelling compound on low spots and sanding the high spots. Also, the Vitronite Slabs should be washed with clean water and properly dried before fixing if necessary.

For the internal or external application, it is essential to select the appropriate cement-based, fiber-reinforced or ready-mixed adhesive to ensure that the Vitronite slabs are properly fixed.

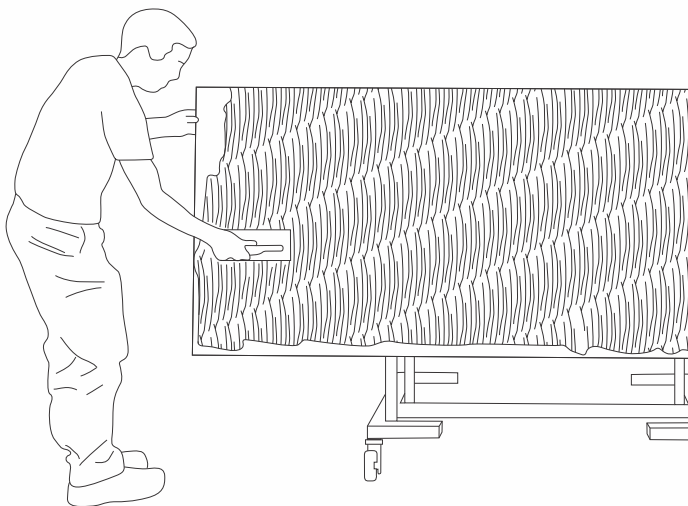
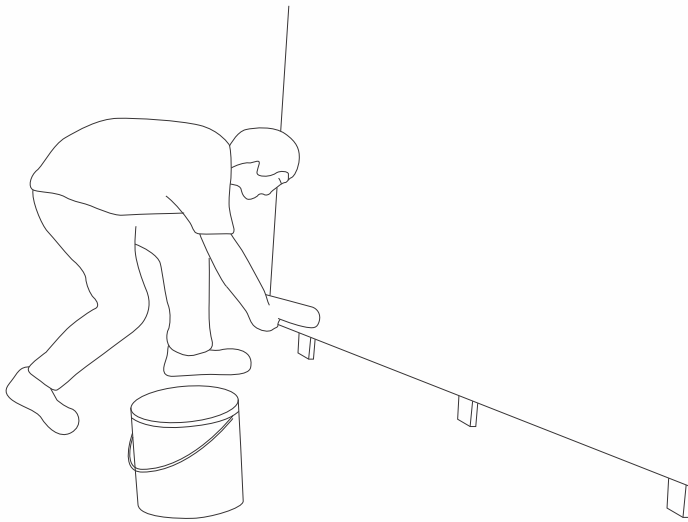
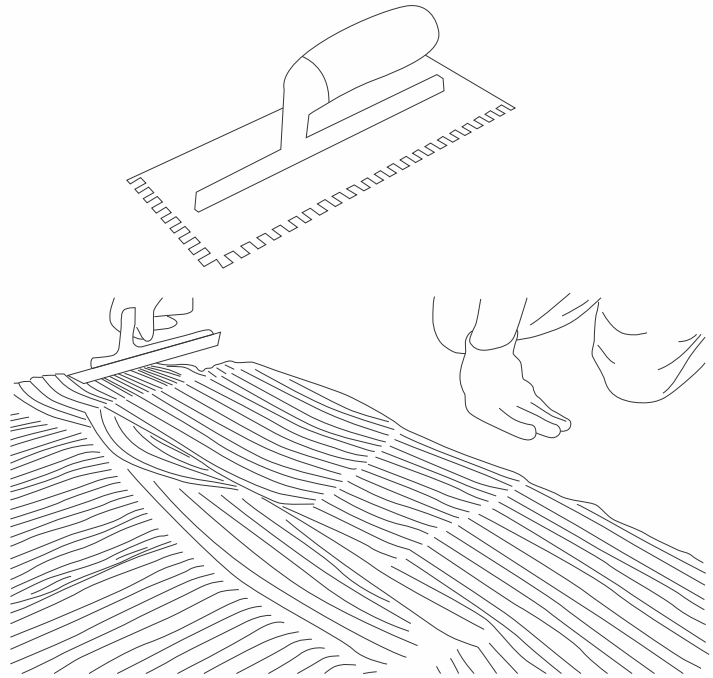

Once the subfloor is clean and ready, the adhesive should be spread evenly covering the entire area using a 10x10mm square toothed trowel. The adhesive should cover 5cm to 10cm more than the size of the Vitronite slab. The adhesive should always be applied in stripes running parallel with the short edge to remove air pockets and bubbles.

The Vitronite slabs require back-buttering due to their large format. Back-buttering means applying a layer of adhesive at the back of the tile using a trowel.

The Vitronite slab should be fixed on a handing frame with the use of suction cups in a vertical position using a specialist wheeled transport cart. To apply adhesive on the floor or wall, a 10x10mm square toothed trowel should be used whereas a 3x3mm square toothed trowel should be used for back-buttering.

After fixing the Vitronite slab on a handing frame with the use of suction cups in a vertical position, it should be lowered slowly in a horizontal position and firmly pressed into the adhesive along a straight edge, collapsing all adhesive ridges. Use a levelling system to avoid lippage and frequently check that the Vitronite slabs are even using a suitable box level. Levelling systems are available with 2mm 3mm and 5mm tile spacers.

Also, you must regularly check the backs of the slabs to make sure that there is full contact between the adhesive and the tile. If not apply additional adhesive to the tile or use a trowel with larger notches in your adhesive. Make sure you wipe off excess mortar with a wet sponge.

LEVELLING

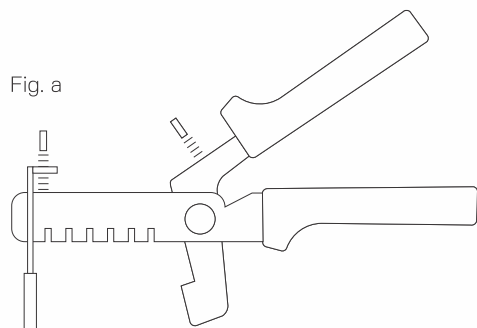
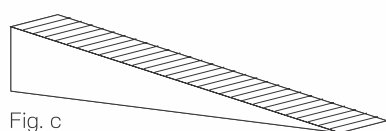
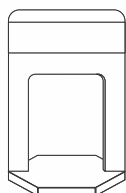

Fig. b



For large-sized tiles like Vitronite slabs, it is highly essential to use levelling systems. Due to the large size and thickness of Vitronite slabs, if a levelling system is not used, it will result in lippage.

Once the first Vitronite slab is laid and leveled, leveling clips should be inserted (Fig. b) before laying the second slab and tap it to ensure a firm bond. Then, adjust the level (Fig. c) of both slabs by pushing the wedges into place with the levelling pliers (Fig. a).

Lippage to the Vitronite slabs is caused depending upon how much warpage the slabs have, the width of the grout, how flat the substrate is, and the expertise of the tile installer. We recommend that lippage should not exceed 2mm for this type of installation.

In order to ensure a uniform surface and produce a surface with acceptable lippage, use a levelling system and frequently check that the Vitronite slabs are even using a suitable box level. Levelling systems are available with 2mm, 3mm and 5mm tile spacers.

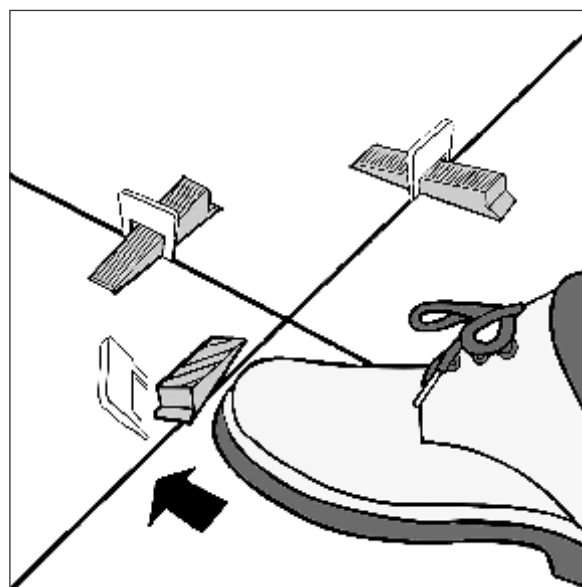
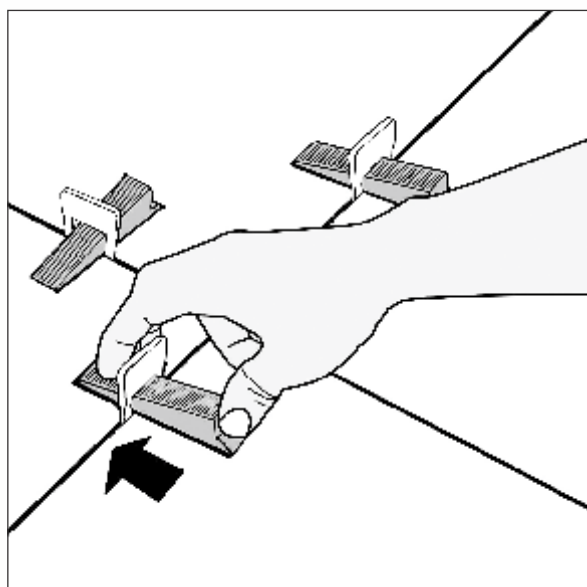
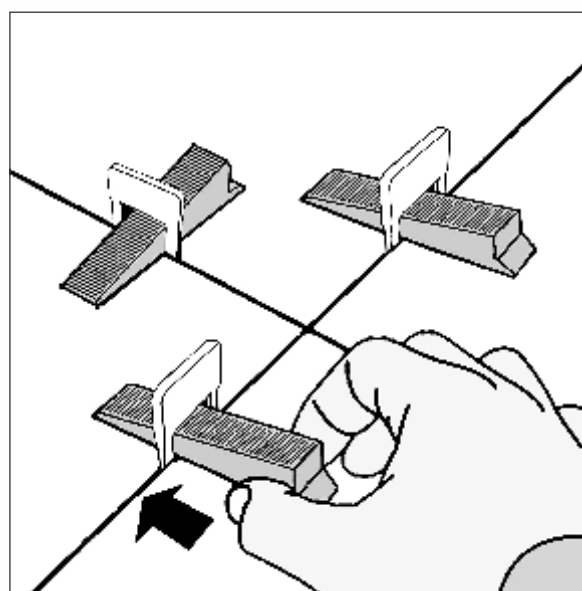
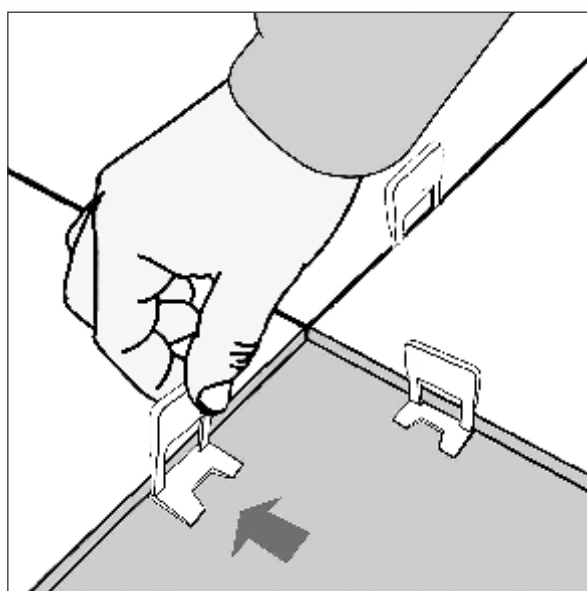

CUTTING

Mark the portion to be cut out from the ends of the Vitronite slab using a pencil. Then, properly position the cutting guide with a cutting carriage so that the references on the guide coincide with the lines marked on the slab. Lock the cutting guide with the cutting carriage in place using the suction cups. It is vital to keep the pressure and movement of the cutting carriage constant along the whole length of the cut to ensure correct scoring.

Score one end of the slab by 15cm pushing the cutting carriage towards the edge of the slab. Complete the scoring up to the opposite end of the slab.

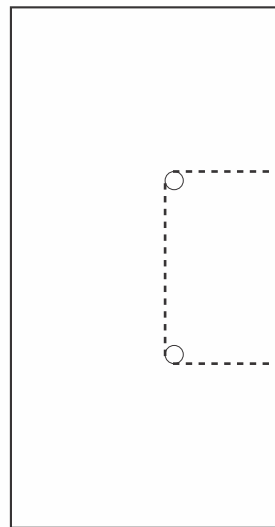
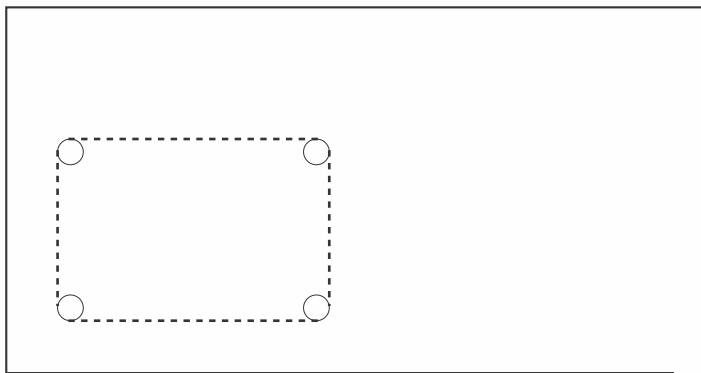
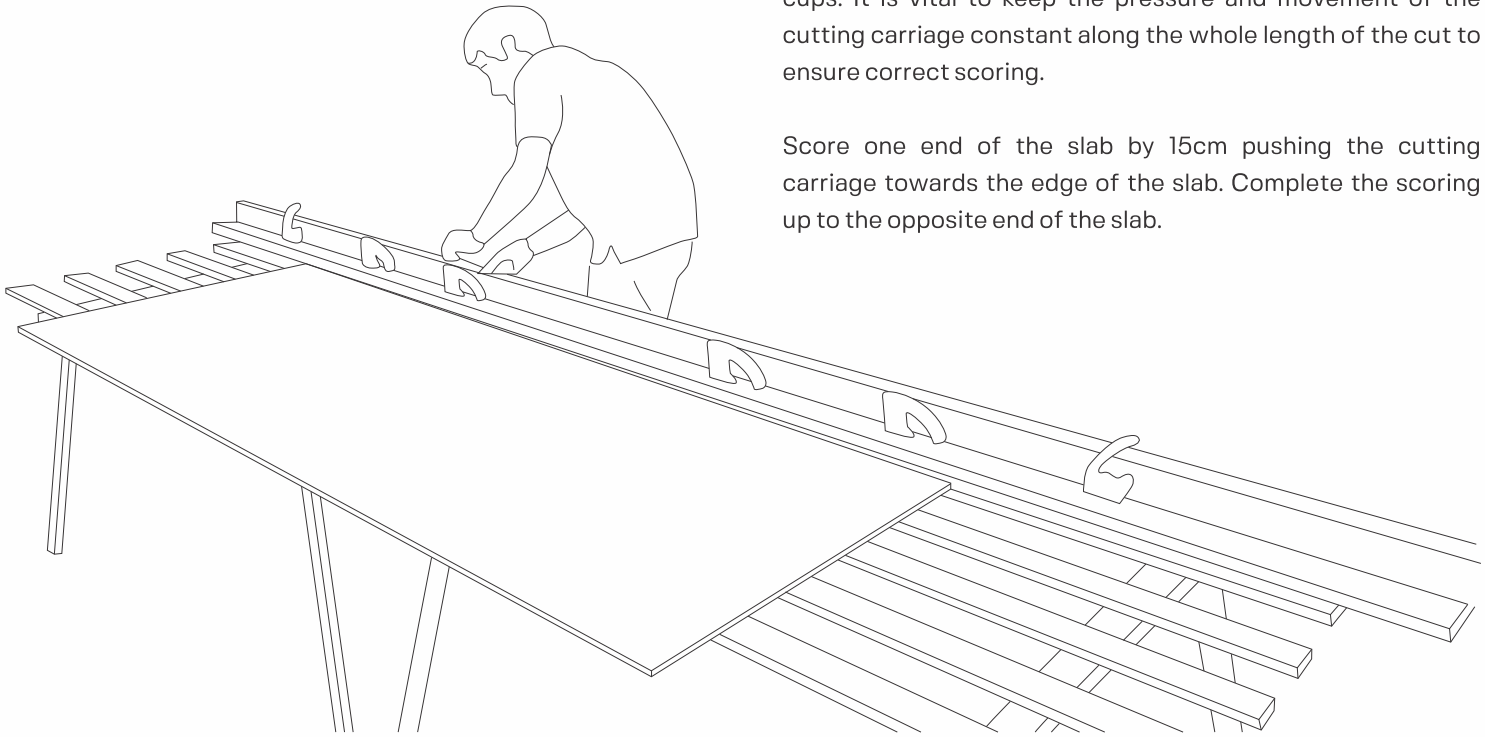

When cutting a "U" shaped piece, mark and drill relief holes where the cut lines intersect, always making the shortest cut first.

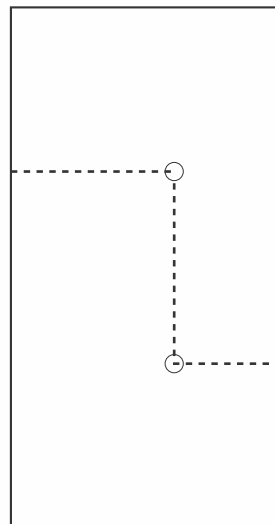
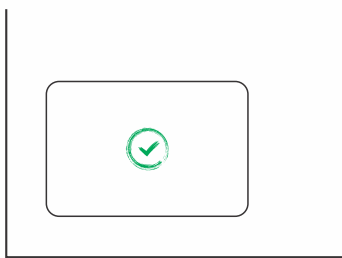

When cutting an "L" countertop, drill relief holes where the cut lines intersect, always making the shortest cut first.

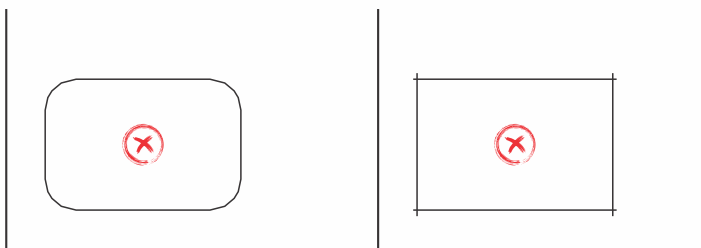

Prepare the holes on all inner corners, minimum 3mm bit diameter.

CLEANING

CLEANING AFTER LAYING

After laying the Vitronite slabs on the floor or wall, it should be cleaned well to remove residual grouting and the normal dirt acquired from building works.

A cementitious descaler can be used for cleaning the joints as it is slightly acidic and does not emit harmful fumes ensuring the safety of the user. In case of material laid with epoxy or resinous grouting, it is recommended to clean after laying with specific detergent.



REGULAR MAINTENANCE

To clean the floor impeccably, we recommend using a natural detergent with high cleaning power. In case of strong dirty and encrusted by the time, we recommend consulting the following scheme to find the perfect solution to every situation:

TYPE OF DIRT	PRODUCT
Cement, Kalkstein, metal tracer, rust	Cementitious descaler
Residuals, stains and halos of epoxy joints	Epoxy descaler
Grease, tire marks, colours, marker, etc.	Non soap degrease
Graffiti	Acetone and antigraffiti star



RECOMMENDATIONS

Drying Process

Once the tiles have been grouted and excess grout has been cleaned off, it is important to wait till the tiled surface is dried completely before cleaning. We recommend waiting for 5 days before cleaning or using the tiled surface.

Protecting from Liquid

The newly tiled surface must be protected from water and moisture while the adhesive and grouting materials are maturing and hardening. This is particularly important for outdoor spaces and areas where there is a risk of freezing.

Damage Prevention

It is important to protect the newly tiled surface against mechanical or chemical damage resulting from subsequent work carried out by other professionals or due to later installations. Damage can be prevented by covering the floor tiles with thick cardboard or similar material.

Cleaning Products

For the final cleaning of the tiled surface, the products used should be compatible with the chemical resistance of the tiles. Avoid using solid detergents with abrasive particles and solutions containing hydrofluoric acid, which attacks the glaze and causes irreversible damage to the ceramic tile.

TECHNICAL SPECIFICATION of FULLBODY VITRIFIED SLAB

CHARACTERISTIC	Group Bla ISO 13006-2018	Group Bla IS :15622:2017	Kajaria Vitronite FULLBODY VITRIFIED SLAB Value	Test According to
Dimensions & surface Quality				
Deviation in length and width	± 0.3%	± 0.1%	± 0.1%	ISO 10545:2/IS:13630 (P-1)
Deviation in thickness	± 5.0%	± 4.0%	± 4.0%	ISO 10545:2/IS:13630 (P-1)
Deviation in Straightness of sides	± 0.3%	± 0.4%	± 0.1%	ISO 10545:2/IS:13630 (P-1)
Deviation in Rectangularity	± 0.3%	± 0.1%	± 0.1%	ISO 10545:2/IS:13630 (P-1)
Deviation in Surface Flatness	± 0.4%	± 0.5%	± 0.2%	ISO 10545:2/IS:13630 (P-1)
Surface Quality (%)	Min. 95%	Min. 95%	No visible defects	ISO 10545:2/IS:13630 (P-1)
Glossiness with Nano	Declared by manu.	-	Minimum 90	ISO 2813 (Glossy meter)
Physical charactersitics				
Scratch Hardness of surface Moh's scale	Required	Min. 5	Min. 5	IS:13630 (P-13)
Water absorption	≤0.5% Ind. max. 0.06%	Avg. ≤0.08, Ind. 0.10% max	<0.05%	ISO 10545:3/IS: 13630 (P-2)
Moisture Expansion	Test method available	Max. 0.02 mm/m	Max. 0.01 mm/m	ISO 10545:10 / IS:13630(P-3)
Deep Abrason	Max. 175mm ³	Max. 140mm ³	Max. 150mm ³	ISO 10545:6/IS:13630 (P-12)
Mechanical charactersitics				
Breaking strength	1300 N	Min. 1300 N	≥ 5000 N	ISO 10545:4/IS: 13630 (P-6)
Modulus of rupture	>35 N/mm ²	Avg. 35, Ind. min. 32	≥ 40 N/mm ²	ISO 10545:4/IS: 13630 (P-6)
Safety charactersitics				
Density	Min 2.20 gm/cc	Min. 2.20 gm/cc	> 2.25 gm/cc	ISO 10545:3 /IS: 13630 (P-2)
Impact resistance (Coefficient of restitution)	Test method available	Min. 0.55	> 0.65	ISO 10545:5/IS: 13630 (P-14)
Skid resistance (Friction coefficient)	Test method available	Test method available	≥ 0.4 *	ISO 10545:17 / ANSI:A326.3
Thermo photo charactersitics				
Thermal shock resistance	Test method available	Min. 10 cycles	Pass min. 10 cycles	ISO 10545:9/IS: 13630 (P-5)
Co efficient of thermal expansion	Test method available	6×10 ⁻⁶ Max.	<6×10 ⁻⁶	ISO 10545:8/IS:13630 (P-4)
Frost resistance	Required	Required	No Damage	ISO 10545:12/IS: 13630 (P-10)
Small colour differences	Plain coloured tiles only where req. ΔE cmc < 0.75	-	No differences	ISO 10545:16
Chemical characteristics charactersitics				
Stain Resistance	Test method available	Min. class - 2	Min. conform to class-4*	ISO 10545:14/IS:13630 (P-8)
Chemical Resistance HOUSE HOLD CHEMICAL & SWIMMING POOL SALT	Min. Class-UB	Class - AA	Conform to classes-UA*	ISO 10545:13/IS:13630 (P-7)
Chemical Resistance LOW CONCENTRATIONS ACID & ALKALIES	Manufacturer is to state classification	Required	Conform to classes-ULA*	ISO 10545:13/IS:13630 (P-7)
Chemical Resistance HIGH CONCENTRATIONS ACID & ALKALIES	Test method available	Required	Conform to classes-UHB*	ISO 10545:13/IS:13630 (P-7)

- » Skid resistance value can be provided according to test method used & surface finish, also area of use.
- » VITRONITE SLAB have resistance to most of the stains/chemicals but it is recommended to take due care while laying and for day-to-day maintenance.
- » We recommend to cover the surface with polythene sheet or any other suitable source before any wall or furniture painting work starts so that beauty of slab surface remains forever.
- » Resistance to acids & alkalies (Exception Hydrofluoric acids & its Compounds)
- » Colours in the catalogue are as accurate as printing process allows. Please check actual sample before making the final selection
- » Sizes mentioned in the catalogue are nominal sizes only.
- » No claim will be entertained once the VITRONITE SLAB are is fixed.
- » For better laying. Please follow the instructions on the packaging box.
- » Please make sure to check the shade/finish with the sales agent/ dealer making the final purchase because there might be variation in actual finish that shown in the catalogue. The company will not bear any loss in such case.

TECHNICAL SPECIFICATION of DIGITAL VITRIFIED SLAB

CHARACTERISTIC	Group Bla ISO 13006-2018	Group Bla IS :15622:2017	Kajaria Vitronite DIGITAL VITRIFIED SLAB Value	Test According to
Dimensions & surface Quality				
Deviation in length and width	± 0.3%	± 0.1%	± 0.1%	ISO 10545:2/IS:13630 (P-1)
Deviation in thickness	± 5.0%	± 4.0%	± 4.0%	ISO 10545:2/IS:13630 (P-1)
Deviation in Straightness of sides	± 0.3%	± 0.4%	± 0.1%	ISO 10545:2/IS:13630 (P-1)
Deviation in Rectangularity	± 0.3%	± 0.1%	± 0.1%	ISO 10545:2/IS:13630 (P-1)
Deviation in Surface Flatness	± 0.4%	± 0.5%	± 0.2%	ISO 10545:2/IS:13630 (P-1)
Surface Quality (%)	Min. 95%	Min. 95%	No visible defects	ISO 10545:2/IS:13630 (P-1)
Glossiness with Nano	Declared by manu.	-	Minimum 90	ISO 2813 (Glossy meter)
Physical charactersitics				
Scratch Hardness of surface Moh's scale	Required	Min. 5	Min. 4	IS:13630 (P-13)
Water absorption	≤0.5% Ind. max. 0.06%	Avg. ≤0.08, Ind. 0.10% max	<0.05%	ISO 10545:3/IS: 13630 (P-2)
Moisture Expansion	Test method available	Max. 0.02 mm/m	Max. 0.01 mm/m	ISO 10545:10 / IS:13630(P-3)
Surface abrasion	Required	Min. Class - 2	PEI class 2-4	ISO 10545:7/IS:13630 (P-11)
Mechanical charactersitics				
Breaking strength	1300 N	Min. 1300 N	≥ 5000 N	ISO 10545:4/IS: 13630 (P-6)
Modulus of rupture	>35 N/mm ²	Avg. 35, Ind. min. 32	≥ 40 N/mm ²	ISO 10545:4/IS: 13630 (P-6)
Safety charactersitics				
Density	Min 2.20 gm/cc	Min. 2.20 gm/cc	> 2.25 gm/cc	ISO 10545:3 /IS: 13630 (P-2)
Impact resistance (Coefficient of restitution)	Test method available	Min. 0.55	> 0.65	ISO 10545:5/IS: 13630 (P-14)
Skid resistance (Friction coefficient)	Test method available	Test method available	≥ 0.4 *	ISO 10545:17 / ANSI:A326.3
Thermo photo charactersitics				
Thermal shock resistance	Test method available	Min. 10 cycles	Pass min. 10 cycles	ISO 10545:9/IS: 13630 (P-5)
Co efficient of thermal expansion	9×10 ⁻⁶ Max	6×10 ⁻⁶ Max.	<6×10 ⁻⁶	ISO 10545:8/IS:13630 (P-4)
Crazing Resistance	Required	4 Cycle Pass	4 Cycle Pass	ISO 10545:11/IS:13630 (P-9)
Frost resistance	Required	Required	No Damage	ISO 10545:12/IS: 13630 (P-10)
Small colour differences	Plain coloured tiles only where req. ΔE cmc < 0.75	-	No differences	ISO 10545:16
Chemical characteristics charactersitics				
Stain Resistance	Min. Class - 3	Min. class - 1	Min. conform to class-4*	ISO 10545:14/IS:13630 (P-8)
Chemical Resistance HOUSE HOLD CHEMICAL & SWIMMING POOL SALT	Min. Class-GB	Class - AA	Conform to classes-GA*	ISO 10545:13/IS:13630 (P-8)
Chemical Resistance LOW CONCENTRATIONS ACID & ALKALIES	Manufacturer is to state classification	Required	Conform to classes-GLA*	ISO 10545:13/IS:13630 (P-8)
Chemical Resistance HIGH CONCENTRATIONS ACID & ALKALIES	Test method available	Required	Conform to classes-GHB*	ISO 10545:13/IS:13630 (P-8)

- » Skid resistance value can be provided according to test method used & surface finish, also area of use.
- » VITRONITE SLAB have resistance to most of the stains/chemicals but it is recommended to take due care while laying and for day-to-day maintenance.
- » We recommend to cover the surface with polythene sheet or any other suitable source before any wall or furniture painting work starts so that beauty of slab surface remains forever.
- » Resistance to acids & alkalies (Exception Hydrofluoric acids & its Compounds)
- » Colours in the catalogue are as accurate as printing process allows. Please check actual sample before making the final selection
- » Sizes mentioned in the catalogue are nominal sizes only.
- » No claim will be entertained once the VITRONITE SLAB are is fixed.
- » For better laying. Please follow the instructions on the packaging box.
- » Please make sure to check the shade/finish with the sales agent/ dealer making the final purchase because there might be variation in actual finish that shown in the catalogue. The company will not bear any loss in such case.

PACKING DETAILS

Dimensions & Thickness (mm)	No. of tiles / box	Coverage Area	Box Weight
800x2400mm (15mm)	1 pc.	1.92 sq. mtr. / 20.666 sq. ft.	68 kg (Avg)

KAJARIA DISPLAY CENTRES / REGIONAL OFFICE



NORTH

CHANDIGARH

SCO- 45-46-47, first floor, sector-17A,
opp. Taj Hotel, Chandigarh-160017
Mobile : 9779042134, 9779009264
Phone : 0172- 4631419 / 16

DELHI

J-1/B-1 (Extn.),
Mohan Co-Operative Industrial Estate,
(Opp. Badarpur Thermal Power Station),
Mathura Road, New Delhi - 110 044. (Delhi)
Mobile : 9717795123, 9717795181

DEHRADUN

International Trade Tower, 1 Old Survey Road,
Adjoining Rajpur Road,, Near Cross Road Mall
Dehradun - 248001, Uttarakhand
Mobile : 97600 40499

JAIPUR

G-1-2, Aishwarya Tower,
Near Hotel Hawa Mahal, Ajmer Road,
Jaipur-302005, (Rajasthan)
Mobile : 9929022124

LUDHIANA

Upper Ground Floor, Sandhu Tower-2,
Gurdev Nagar, Ferozpur Road,
Ludhiana - 141001, Punjab
Mobile : 9779021257

LUCKNOW

529 GHA/06, Kanchana Bihari Marg,
Near Jagrani Hospital, Ring Road
Lucknow - 226016 (U.P.)
Mobile : 9793299660, 8173001374

VARANASI

Rukmani Tower, N8/247-2K-1, DLW,
BHU Road, Newada, Sunderpur
Varanasi-221005, Uttar Pradesh
Mobile : 9794865554, 9005065656

WEST

MUMBAI

B1-307, BOOMERANG, Chandivali Farm Road,
Near Chandivali Studio, Off Saki-Vihar Road,
Andheri (E) Mumbai - 400072, (Maharashtra)
Mobile : 9987753947,9987753948

PUNE

601-A, D.S.K. Gandharv Heights,
Ganesh Khind Road, Shivaji Nagar,
Pune - 411005, (Maharashtra)
Mobile : 7028005373

AHMEDABAD (Regional office)

Kajaria Ceramics Ltd.
Office No. 504, City Centre-2, 5th Floor,
Nr. Sukan Mall Cross Road,
Science City Road, Sola, Ahmedabad -380060
Mobile :9724340890

CENTRAL

RAIPUR

1st Floor, Maharaja Plaza, Near Wholesale
Fruit Market, Dhamtari Road, Laalpur
Raipur-492001, Chhattisgarh
Mobile : 9755007408

INDORE (Regional office)

Kajaria ceramics Ltd.
S.A. Tower, 1st Floor, 13/3 New Palasia,
Opp. Arya Samaj Building, Indore, 452001
Mobile: 73140 68839 / 73140 68803

EAST

KOLKATA (Regional office)

Tirupati Plaza, 2nd Floor, 74/2, A.J.C.Bose Road,
Opp to Jora Girja,
Kolkata - 700 016 (West Bengal)
Mobile: 9007011023

SOUTH

BANGALORE

Farah Icon, 119 First Floor
Opp. New Pass Port Kendra, Lalbagh Road,
Bangalore – 560 027, (Karnataka)
Mobile : 9008098325, 9008007336, 90082 78672
900840 2940, 900840 2922

CHENNAI

Old No.121, New No.38, Arihant jashn Building,
Rukmani Lakshmiipathi Salai, Opp to Rajarathinam Stadium,
Egmore, Chennai - 600008, TamilNadu
Mobile : 9003077099
Phone : 044-28594990 / 28594991

COCHIN

MN Square, 1st Floor
549/2, Near Gold Souk Grande
NH Bypass, Vyttila, Cochin- 19, (Kerala)
Mobile : 9746474732, 9746474739, 9746474733

COIMBATORE

First Floor , No.57, Cowley Brown Road,
R.S Puram, Coimbatore - 641002, (Tamil Nadu)
Mobile : 9003325075

HYDERABAD

Keerthi & Pride Towers, House No. 8-2-120/86/1&2,
3rd Floor, plot No.11 & 12, Road No.2, Banjara Hills
Hyderabad-500034, (Telangana)
Mobile : 9000005385

VIJAYWADA

61-3/4-1, 1st Road, Geetha Nagar, Beside SBI Bank,
NH-5,Vijaywada-520013, (Andhra Pradesh)
Mobile : 7799660222, 9000302776

SALES REPRESENTATIVE

NORTH

AGRA :

Mobile : 9760045574

ALLAHABAD :

Mobile : 9773983600

BHATINDA :

Mobile : 9501001162

FARIDABAD :

Mobile : 9717219345

GURGAON :

Mobile : 9717795118
9650065523

GHAZIABAD :

Mobile : 9810010240

GORAKHPUR :

Mobile : 8009407878

HALDWANI :

Mobile : 9760098112

HISSAR :

Mobile : 9996907982

JALANDHAR :

Mobile : 9779021261

JAMMU :

Mobile : 9906909300

JODHPUR :

Mobile : 9001094759

KANPUR :

Mobile : 8173001374

GHAZIABAD/ NOIDA :

Mobile : 9810010240

ROHTAK :

Mobile : 9996907982

SHIMLA

Mobile : 9501001163

UDAIPUR :

Mobile : 9001092597

EAST

BIHAR :

Mobile : 7781005449

JHARKHAND :

Mobile : 9938234060

WB/NE

Mobile : 9007372220

ODISHA

Mobile : 9937571222

SOUTH

BANGALORE:

Mobile : 90082 78672, 900840 2940,
900840 2922

CALICUT:

Mobile : 9746117422

KANNUR :

Mobile : 9746474736

HUBLI :

Mobile : 9008022099

MADURAI :

Mobile : 9840284411

MANGALORE :

Mobile : 9008402944

SALEM :

Mobile : 9003842142

TRIVANDURM :

Mobile : 9746474735

TRICHY :

Mobile : 9003075175

THRISSUR :

Mobile : 9746474734

VIJAYAWADA :

Mobile : 9000005385

WEST

KOLHAPUR :

Mobile : 8600992617

NASIK :

Mobile : 9730081553

GOA :

Mobile : 7757032203

SURAT :

Mobile : 9724340890

BARODA :

Mobile : 9205897978

CENTRAL

BILASPUR :

Mobile : 9752593830

JABALPUR :

Mobile : 9752593831

GWALIOR :

Mobile : 9752593834

BHOPAL :

Mobile : 7389035949





Kajaria

Kajaria

INDIA'S NO. 1 TILE COMPANY

Kajaria Ceramics Limited

Corporate Office: J1/B1 (Extn.), Mohan Co - op Industrial Estate, Mathura Road, New Delhi - 110044, Ph.: +91-11-26946409

Regd Office: SF-11, Second Floor, JMD Regent Plaza, Mehrauli Gurgaon Road, Village Sikanderpur Ghosi, Gurgaon-122001, Haryana, Ph.:+91-0124-4081281

CIN No. : L26924HR1985PLC056150, E-mail: info@kajariaceramics.com, Web.: www.kajariaceramics.com

 facebook.com/KajariaCeramicsLimited  twitter.com/KajariaCeramic, Tollfree : 1800-11-2992

Download Kajaria App

